



# COLOR MONITOR

DP17L\*

(For implementing TDA9113)

# *SERVICE* Manual SUPPLEMENT-1

**Supplement** to the Service Manual DP17L\*

This supplement contains information which differs from service manual DP17LS/LT  
Use both this supplement and service manual part number BH68-00129A.

## COLOR MONITOR

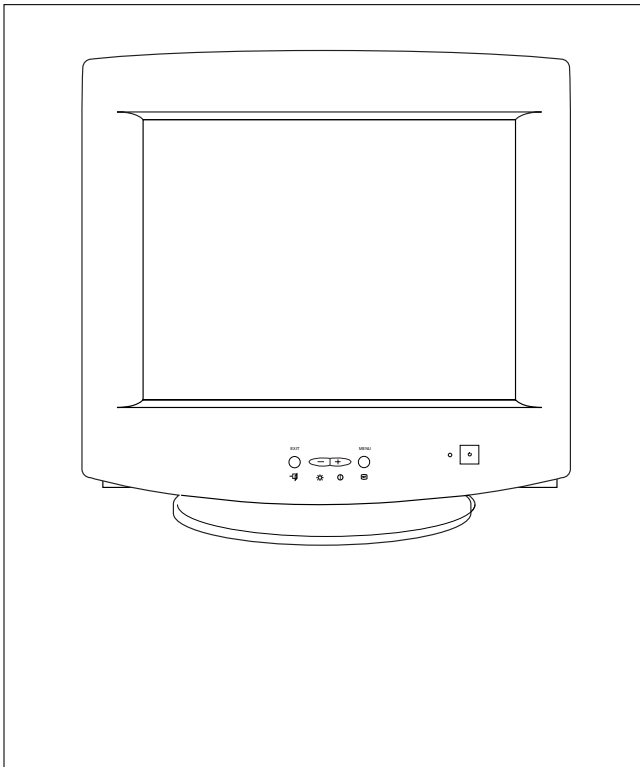

## CONTENTS

1. Troubleshooting
2. Electrical Parts List
3. Schematic Diagrams



**Copyright**

© 2000 by Samsung Electronics Co., Ltd.

All rights reserved.

This manual may not, in whole or in part, be copied, photocopied, reproduced, translated, or converted to any electronic or machine readable form without prior written permission of Samsung Electronics Co., Ltd.

DP17L\* Service Manual  
First edition October 2000.

Printed in Korea.

**Trademarks**

Samsung is a registered trademark and DP17L\* and MacMaster Cable Adapter are trademarks of Samsung Electronics Co., Ltd.

Macintosh, Centris, Quadra, Duo Dock, and Power Macintosh are trademarks of Apple Computer, Inc.

All other trademarks are the property of their respective owners.

# 1 Troubleshooting

## 1-1 Parts Level Troubleshooting

- Notes:**
- If a picture does not appear, fully rotate the brightness and contrast controls clockwise and reinspect.
  - Check the following circuits.
    - No raster appears: Power circuit, Horizontal output circuit.
    - High voltage develops but no raster appears: Video output circuits.
    - High voltage does not develop: Horizontal output circuits.

### 1-1-1 No Power Supply

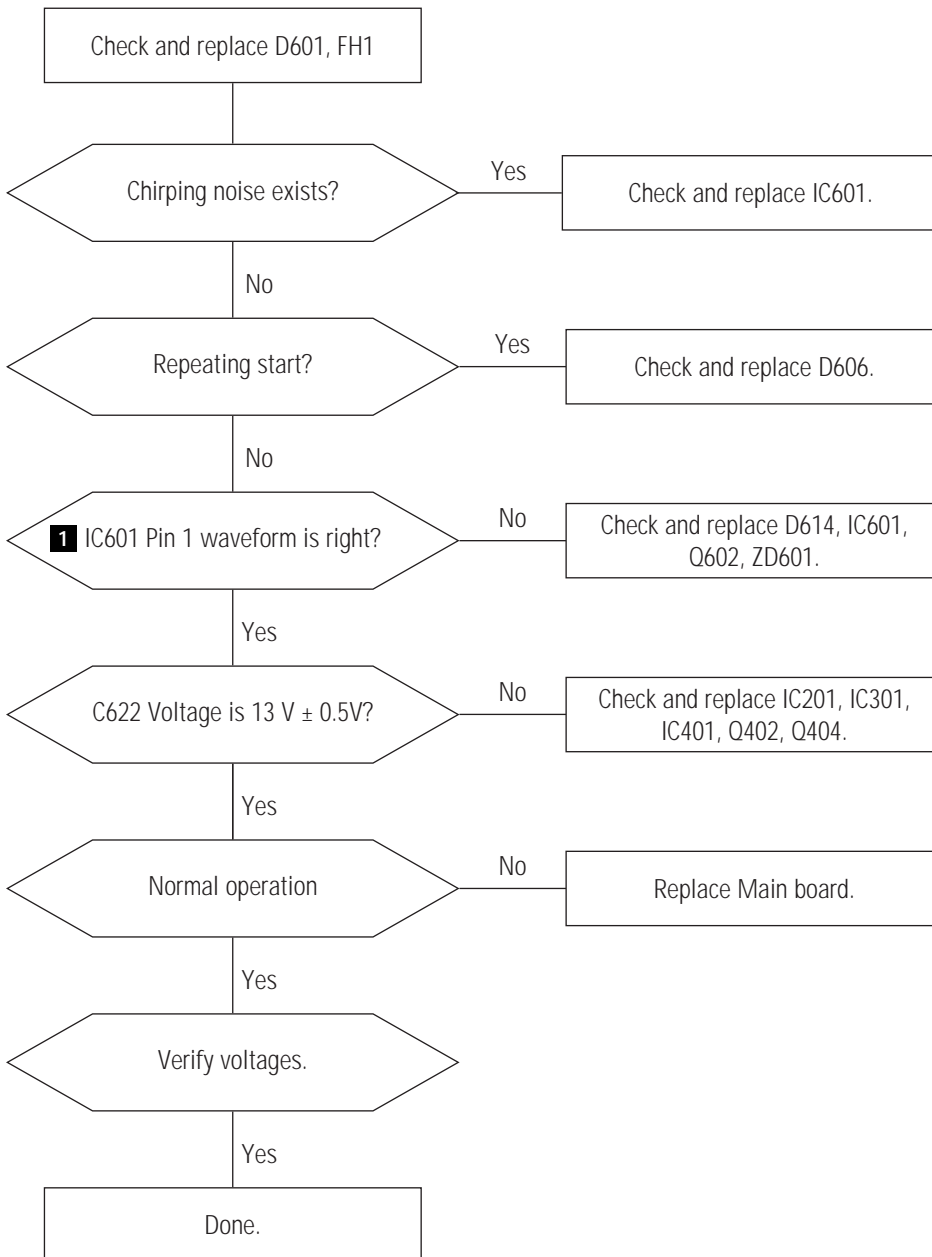

### WAVEFORMS

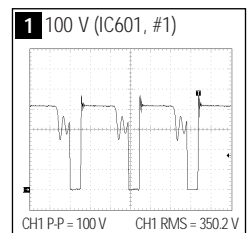

### 1-1-2 DPMS Failure

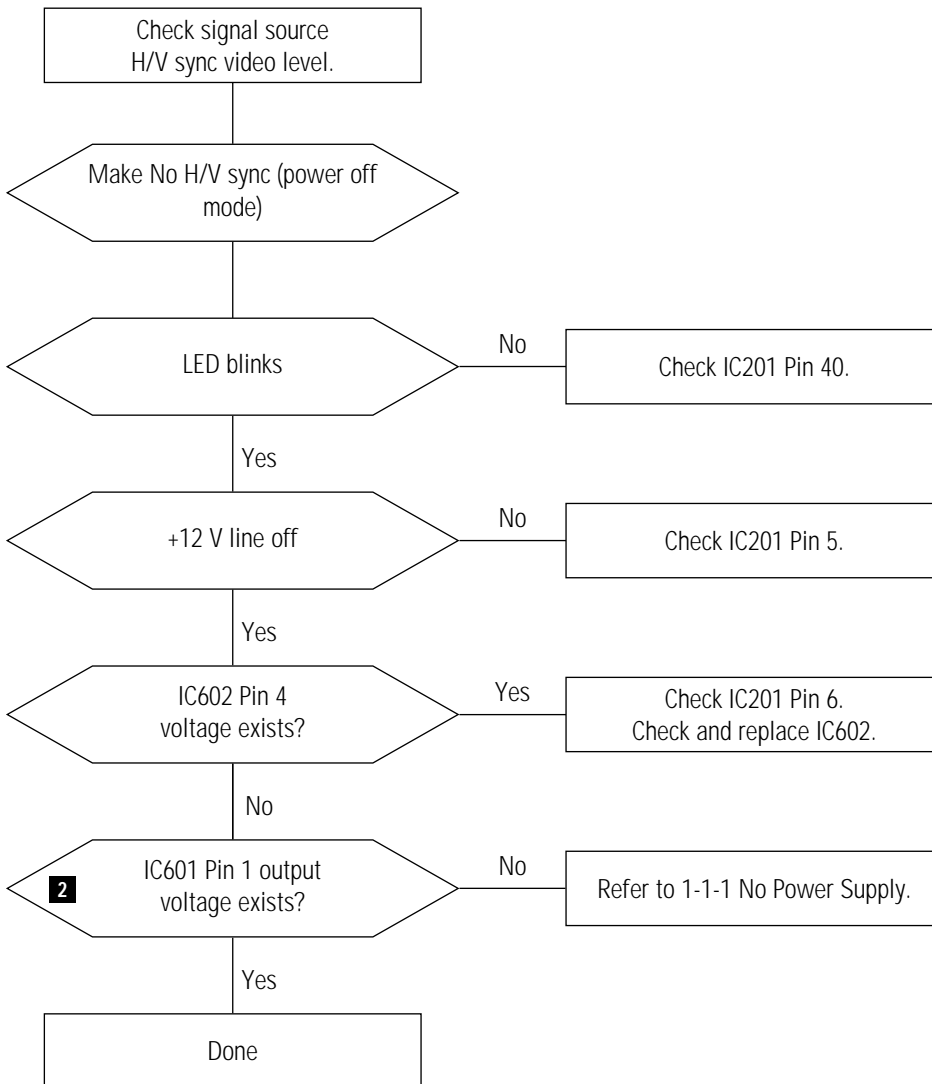

### WAVEFORMS

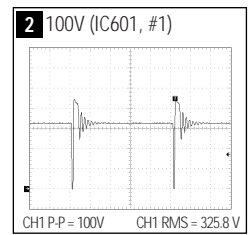

### 1-1-3 H\_Deflection Failure

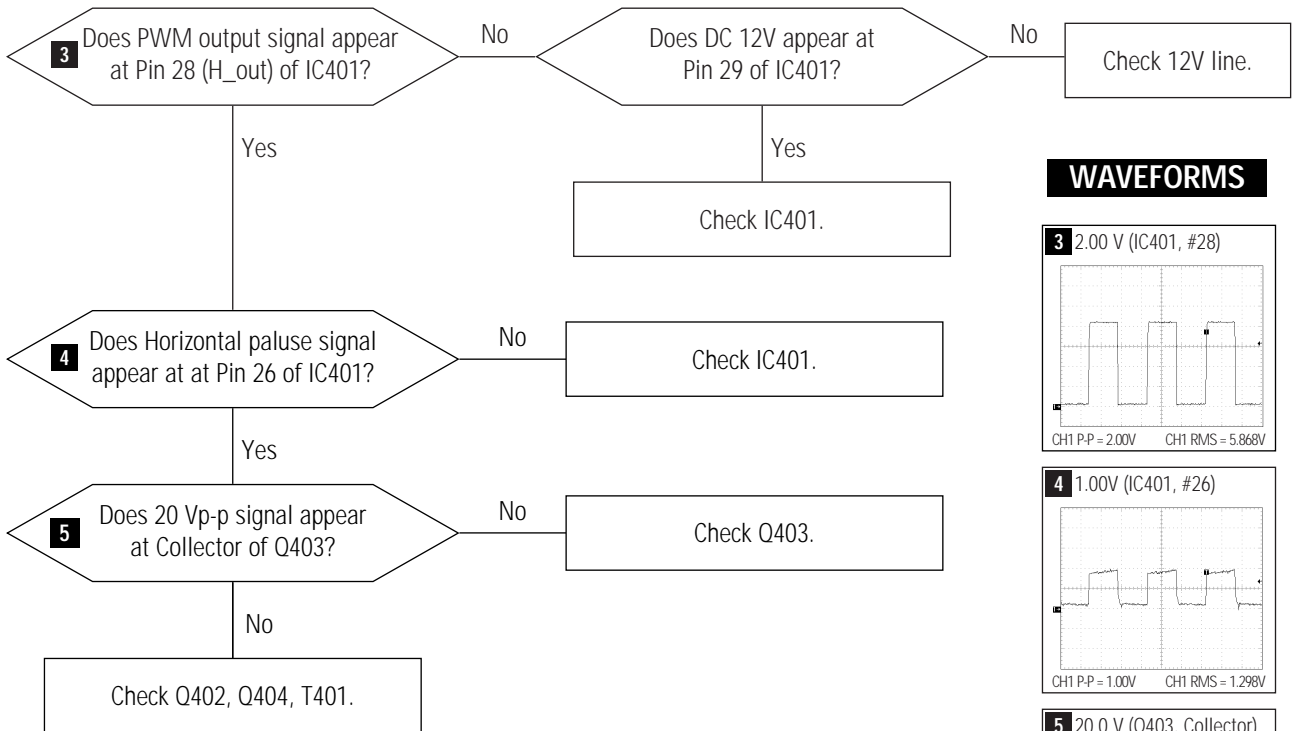

#### WAVEFORMS

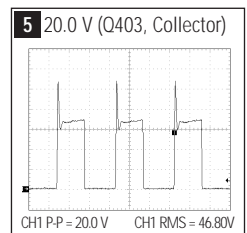
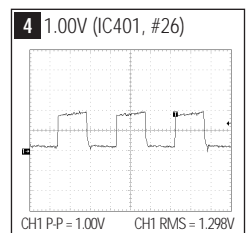
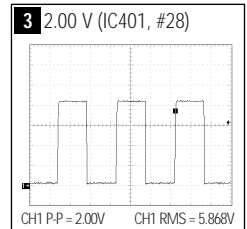

### 1-1-4 S Correction Failure

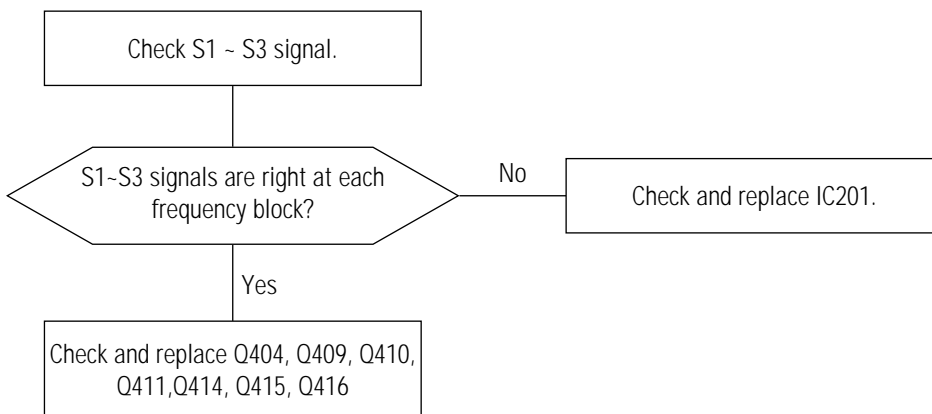

### 1-1-5 H\_Lin. Failure

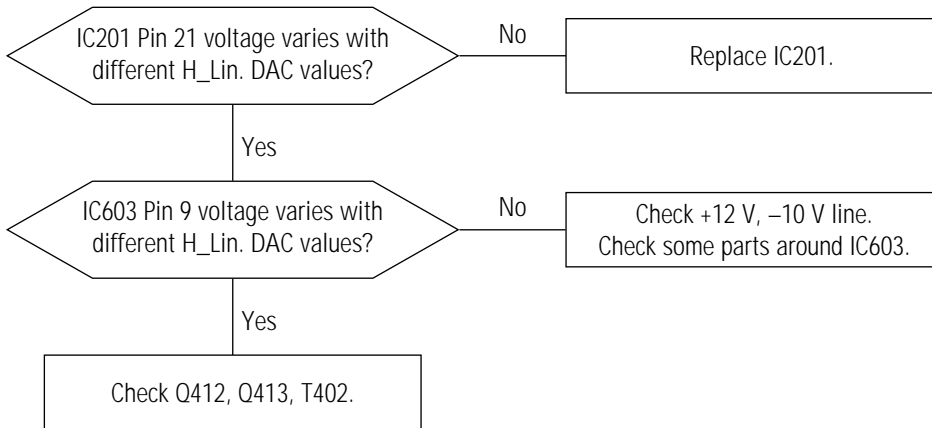

### 1-1-6 Invariable H\_Size

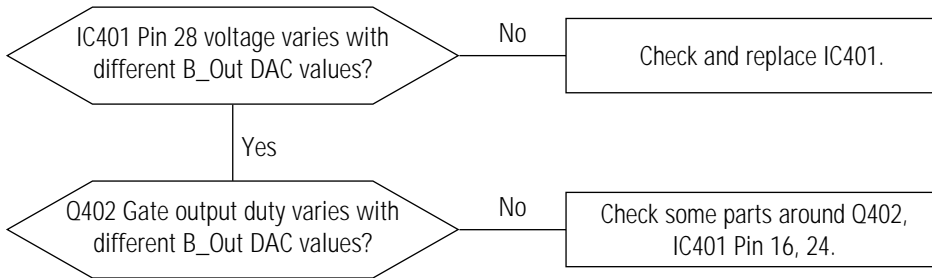

### 1-1-7 Abnormal H\_Size

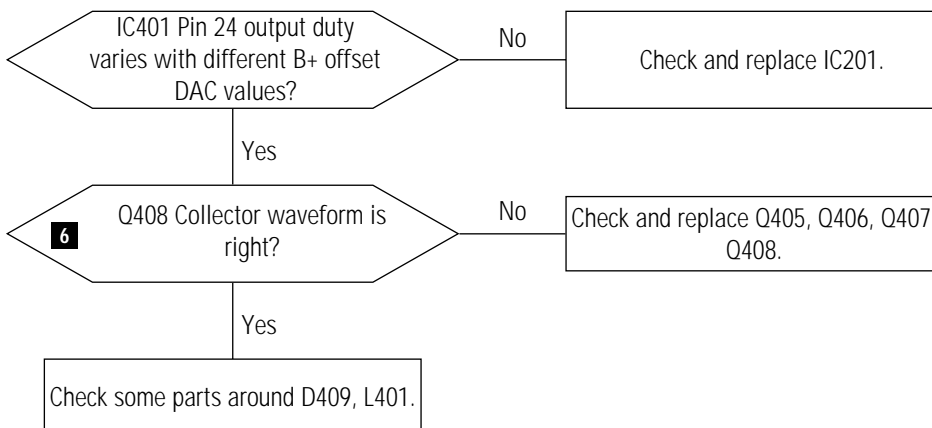

#### WAVEFORMS

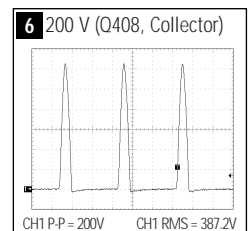

### 1-1-8 Side Pin or Trap Failure

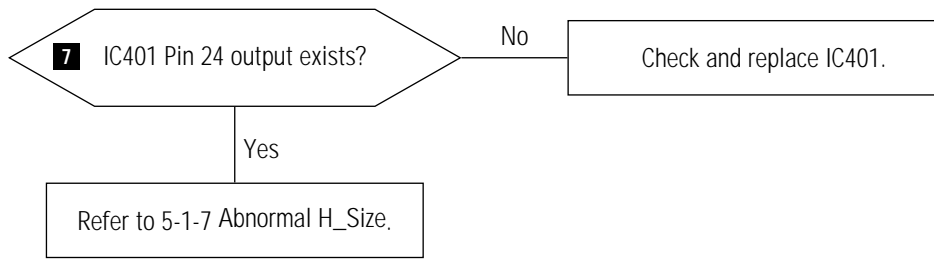

### WAVEFORMS

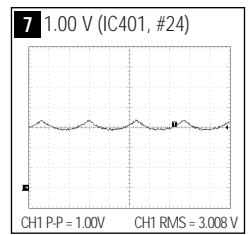

### 1-1-9 Para. or Pin Balance Failure

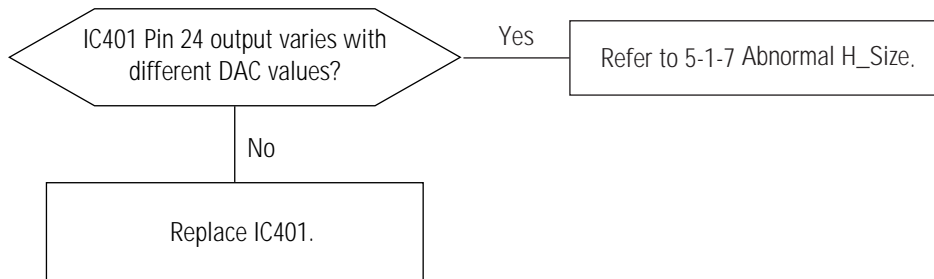

### 1-1-10 Tilt Failure

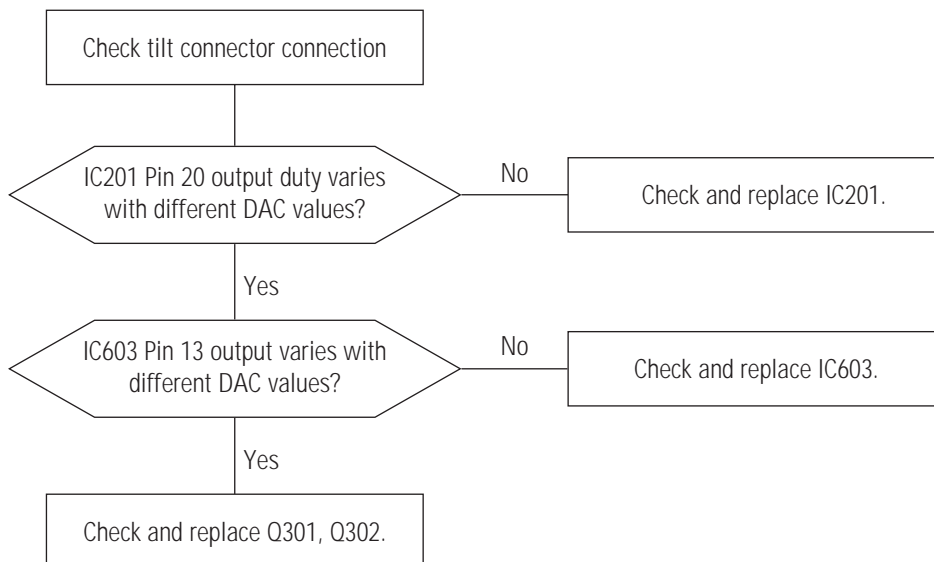



### 1-1-11 V Deflection Failure

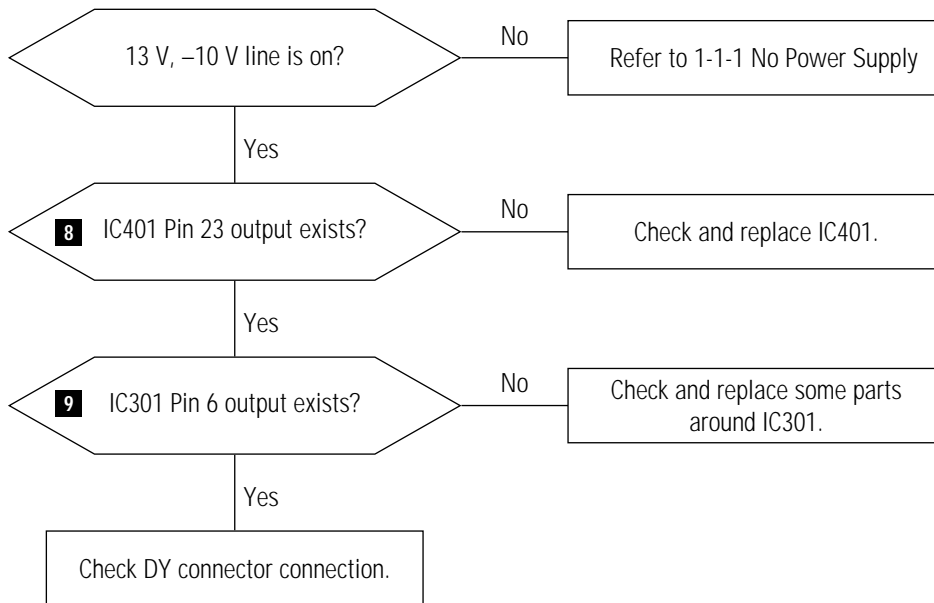

#### WAVEFORMS

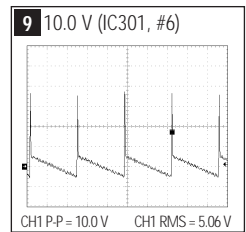
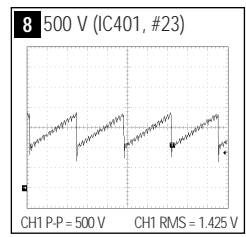

### 1-1-12 V Size or Pos. Variation Failure

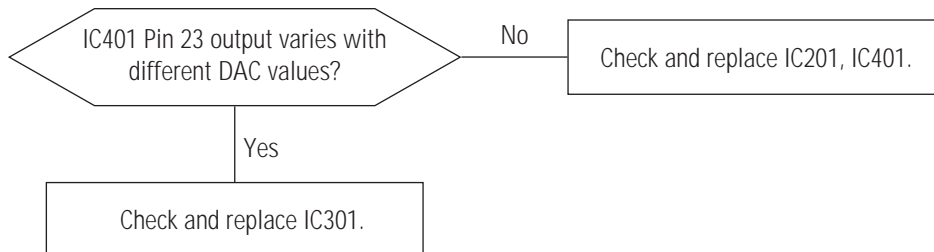

### 1-1-13 High Voltage Failure

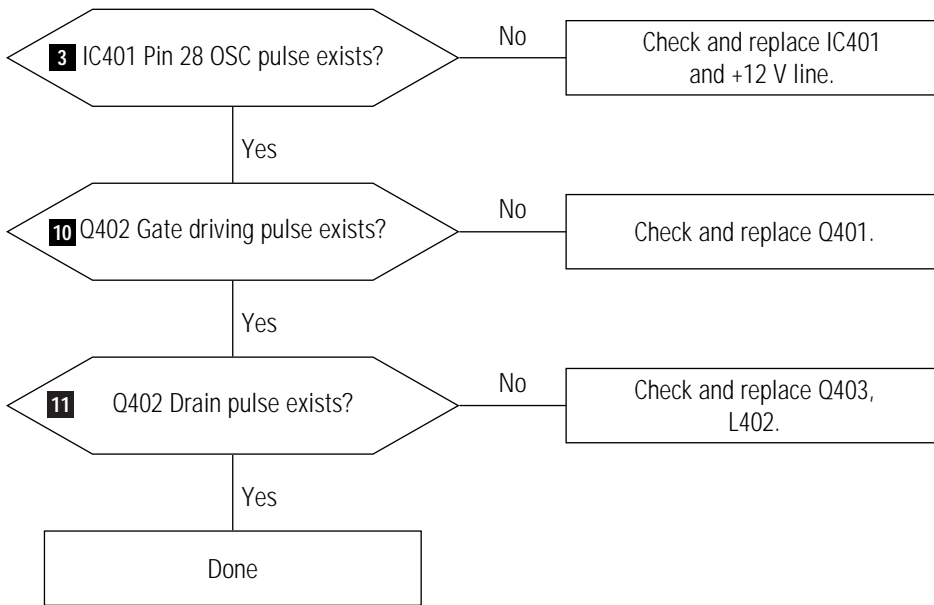

#### WAVEFORMS

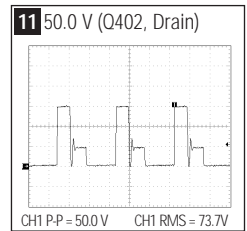
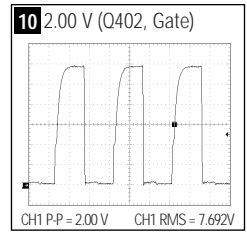
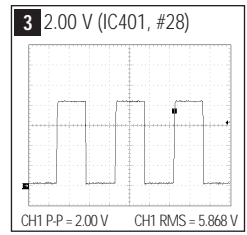

### 1-1-14 ABL Failure

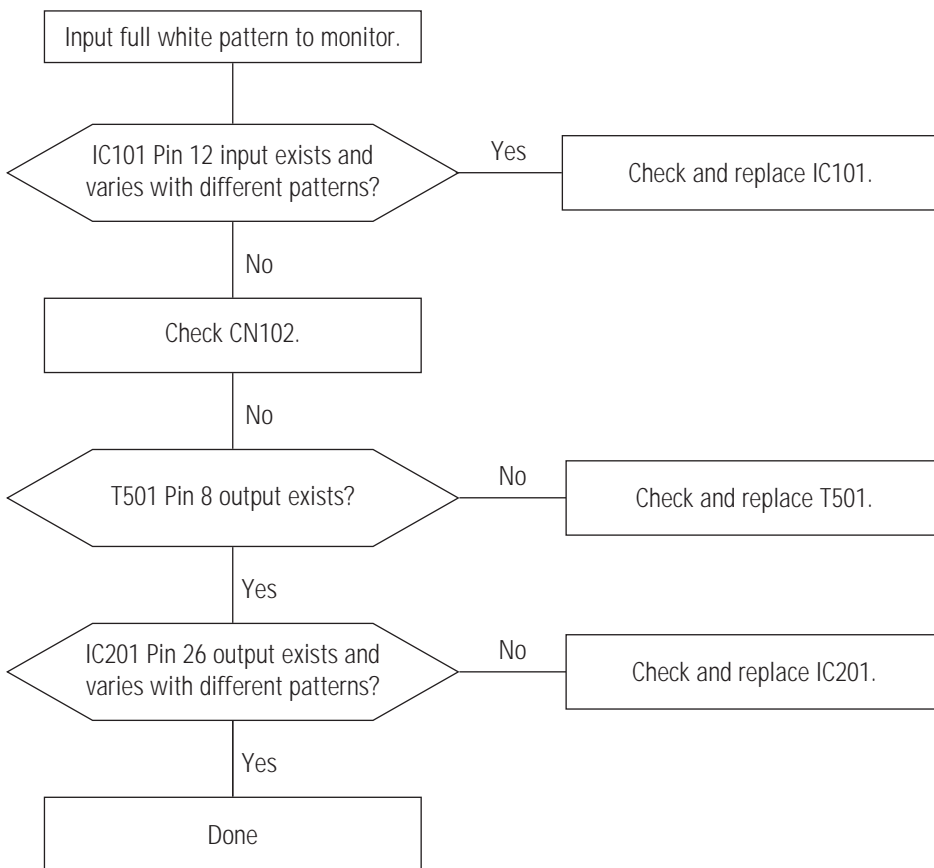

### 1-1-15 Dynamic Focus Failure

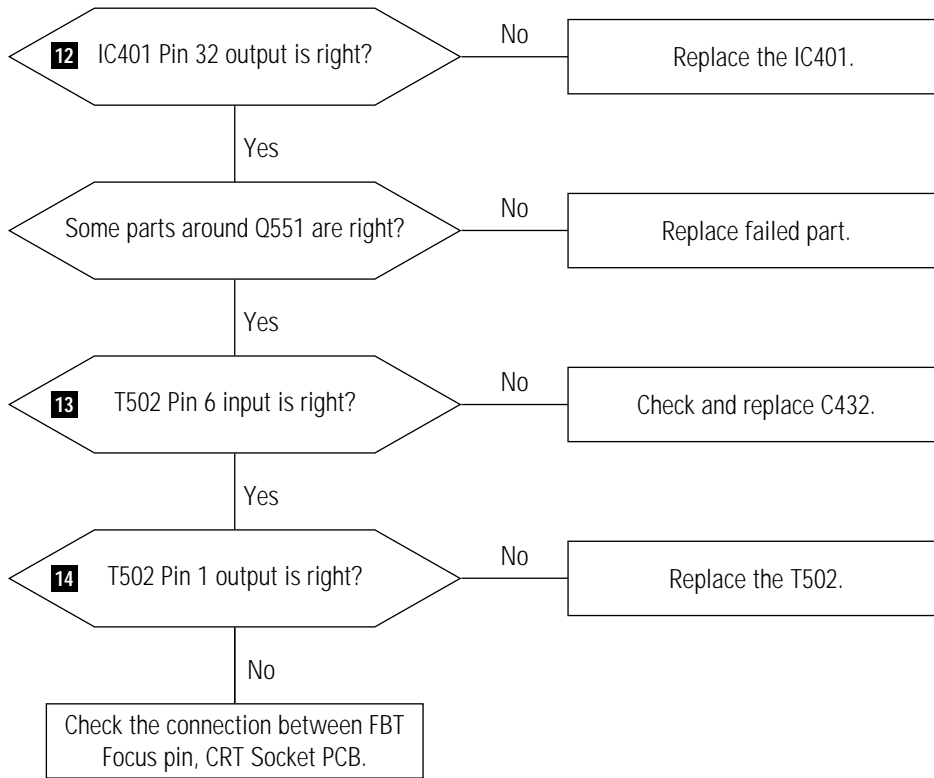

### WAVEFORMS

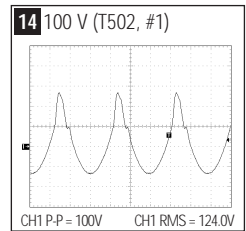
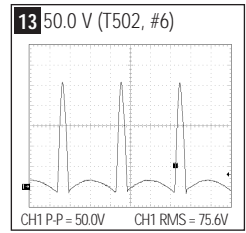
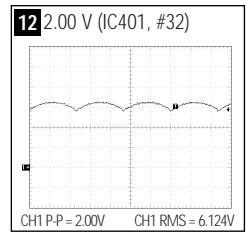

1-1-16 No Video

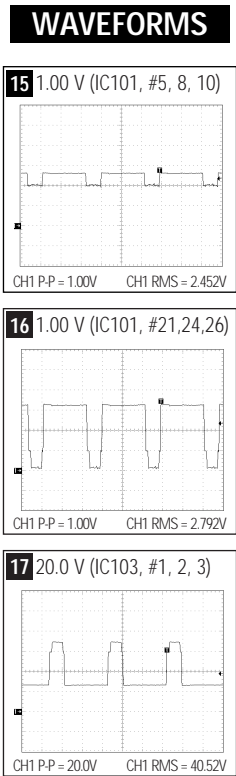
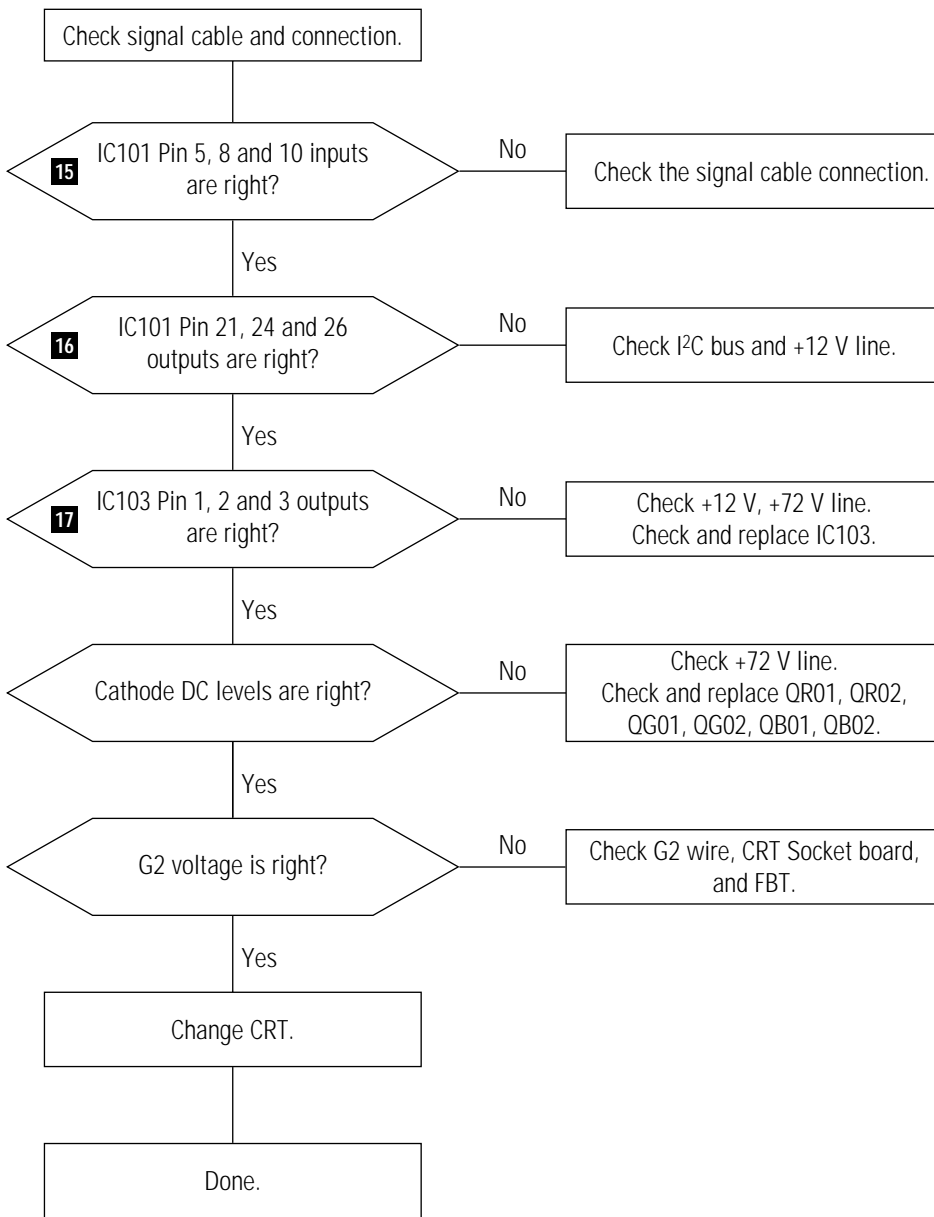

### 1-1-17 Micom Failure

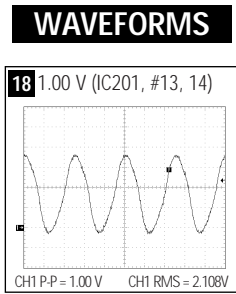
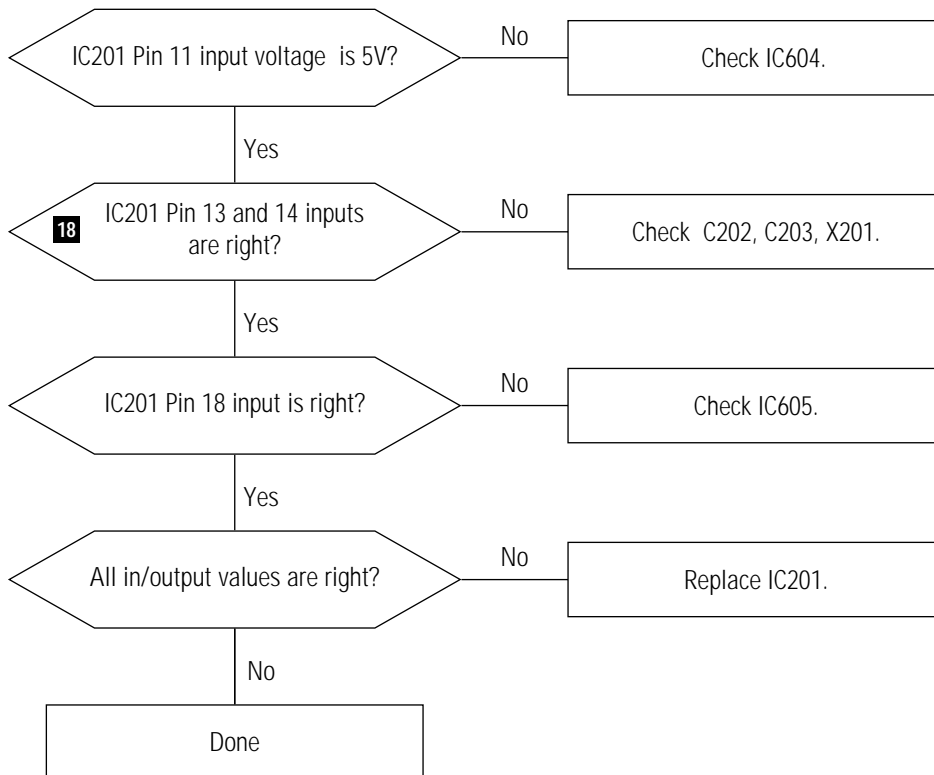

1-1-18 OSD Failure

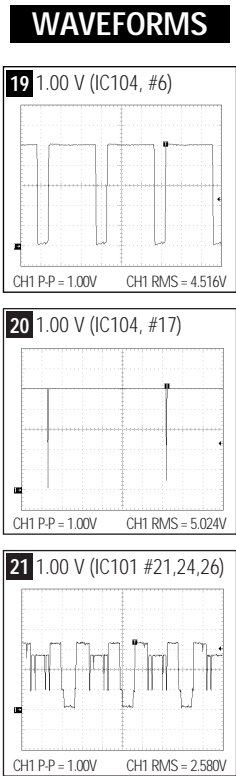
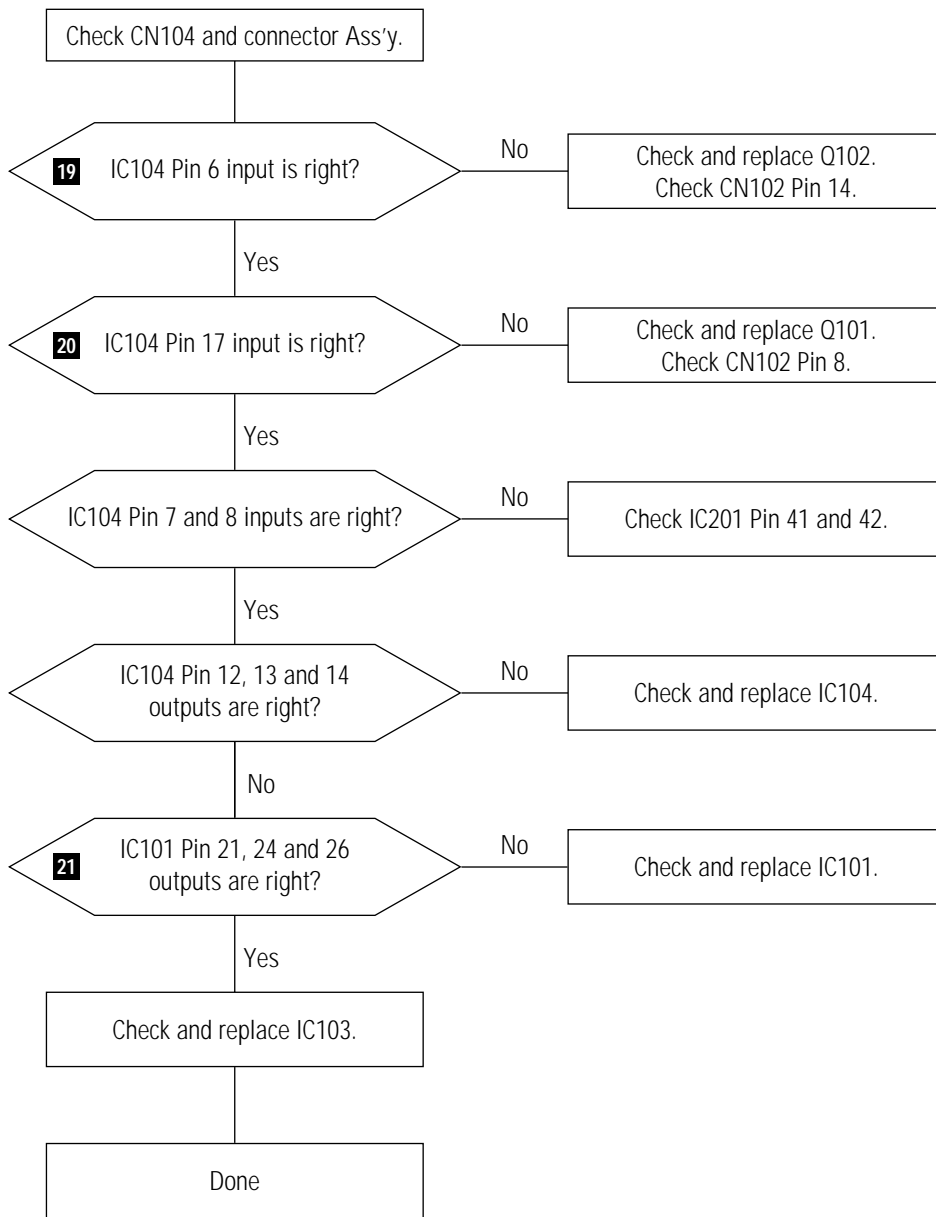

### 1-1-19 User Control Failure

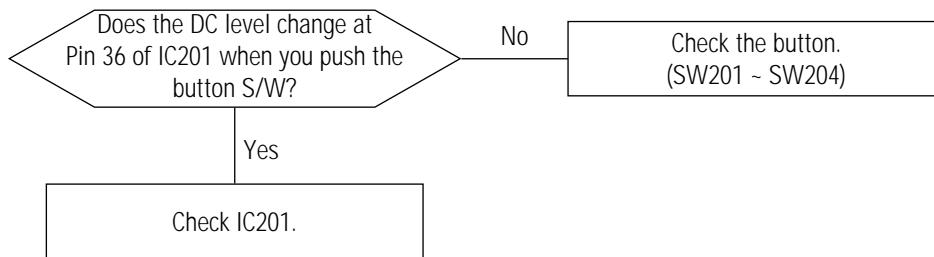

### 1-1-20 Degaussing Failure

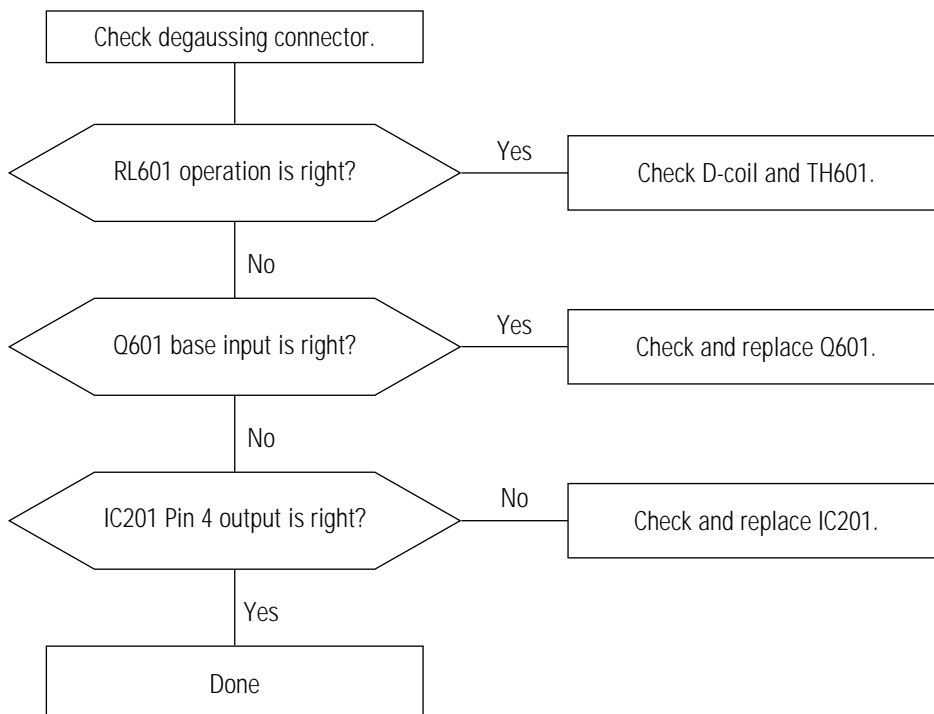

## 1-2 General Troubleshooting

---

### 1-2-1 No Picture

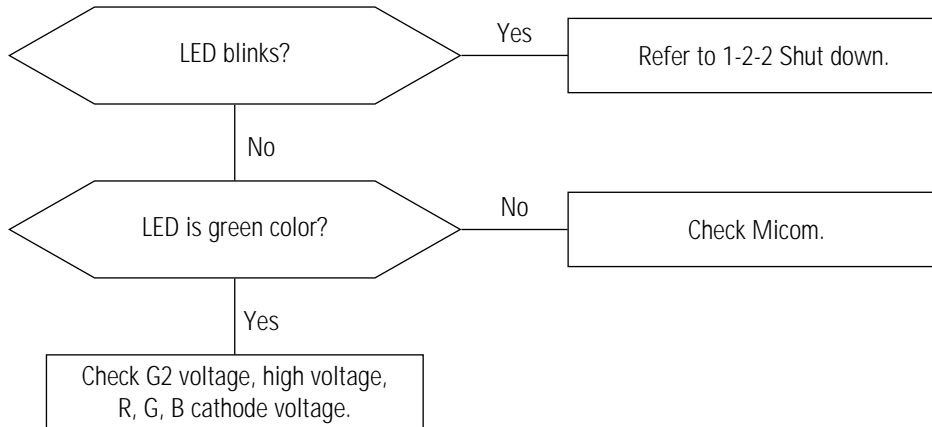

### 1-2-2 Shut Down

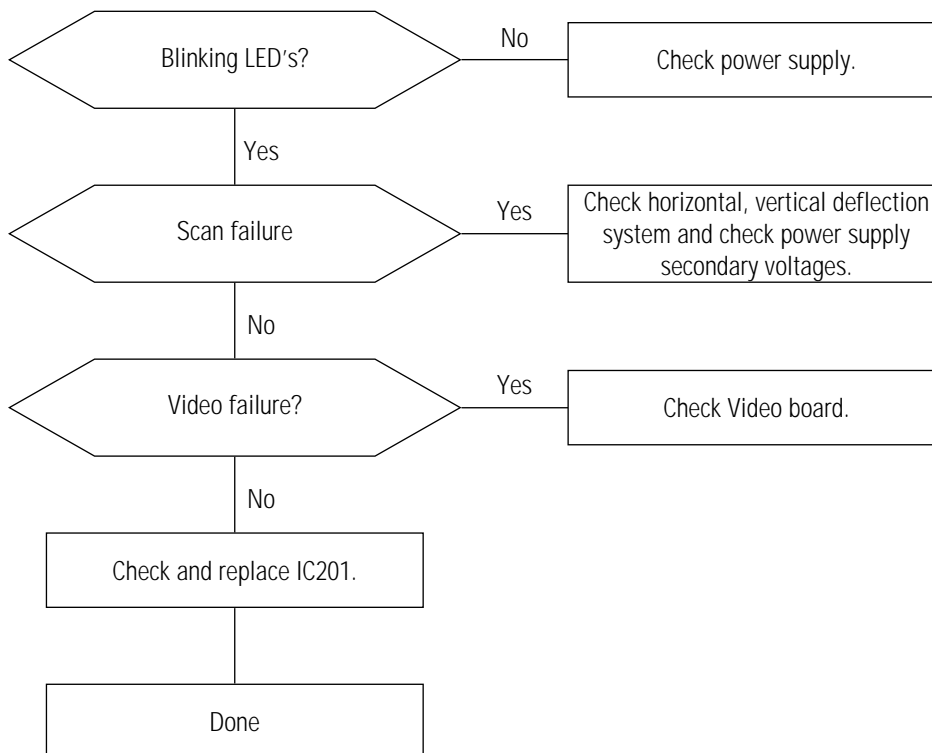



### 1-2-3 Missing Color

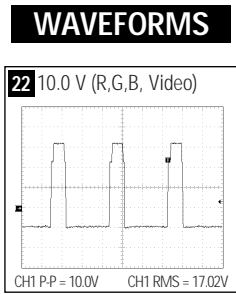
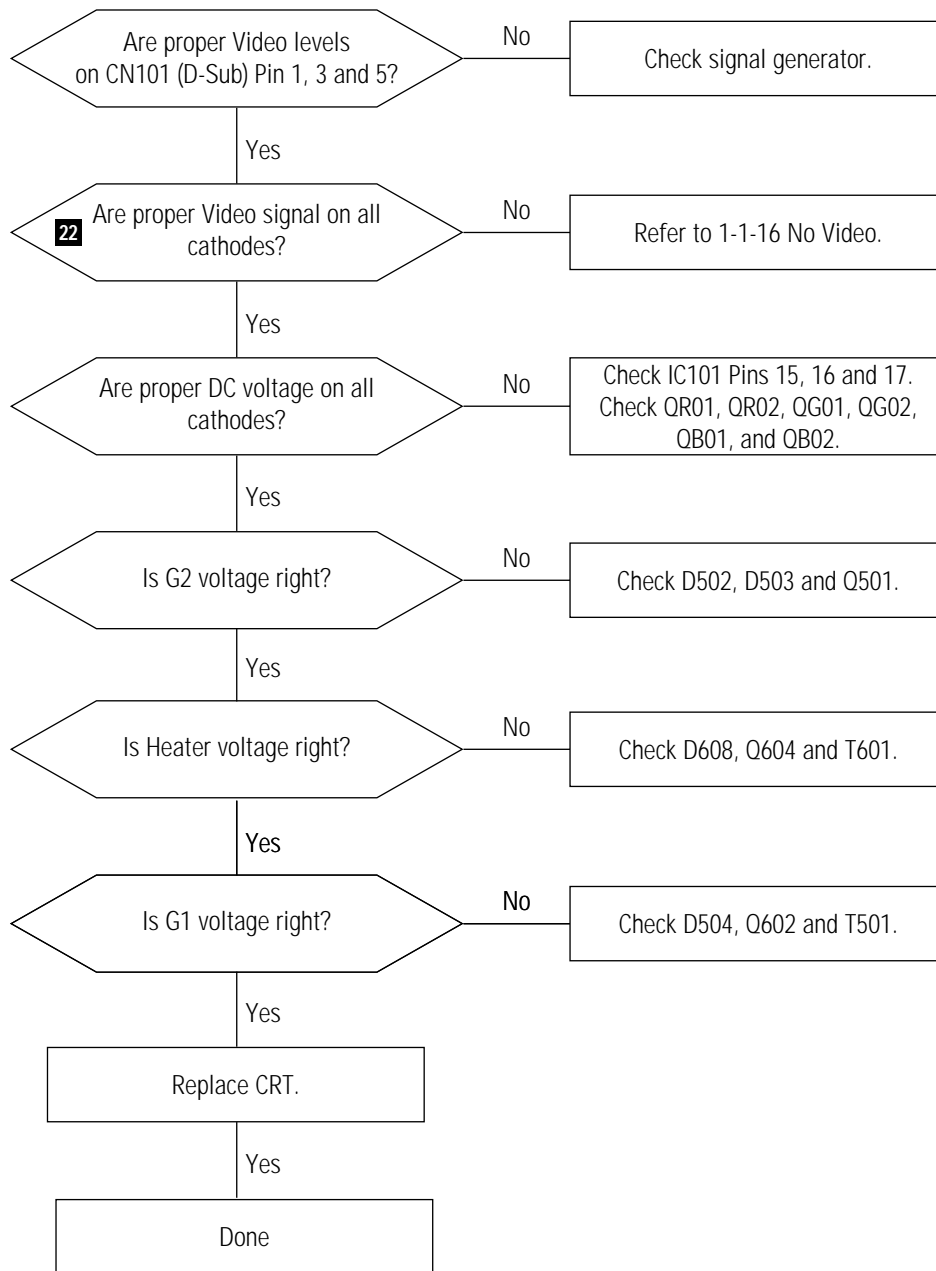

### 1-2-4 Visible Retrace

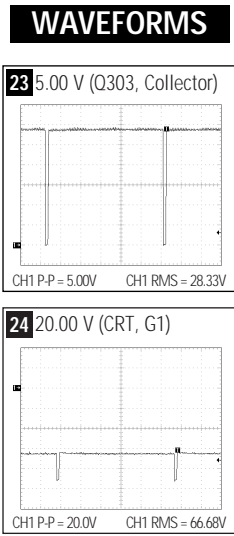
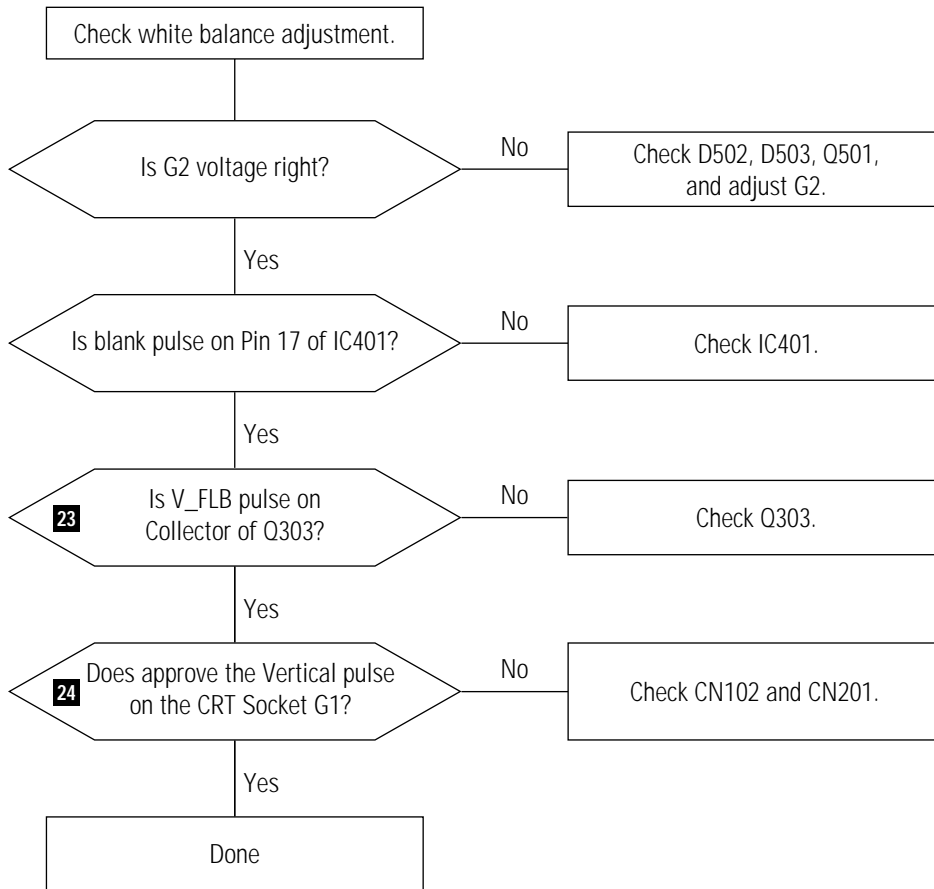

### 1-2-5 Unsynchronized Image

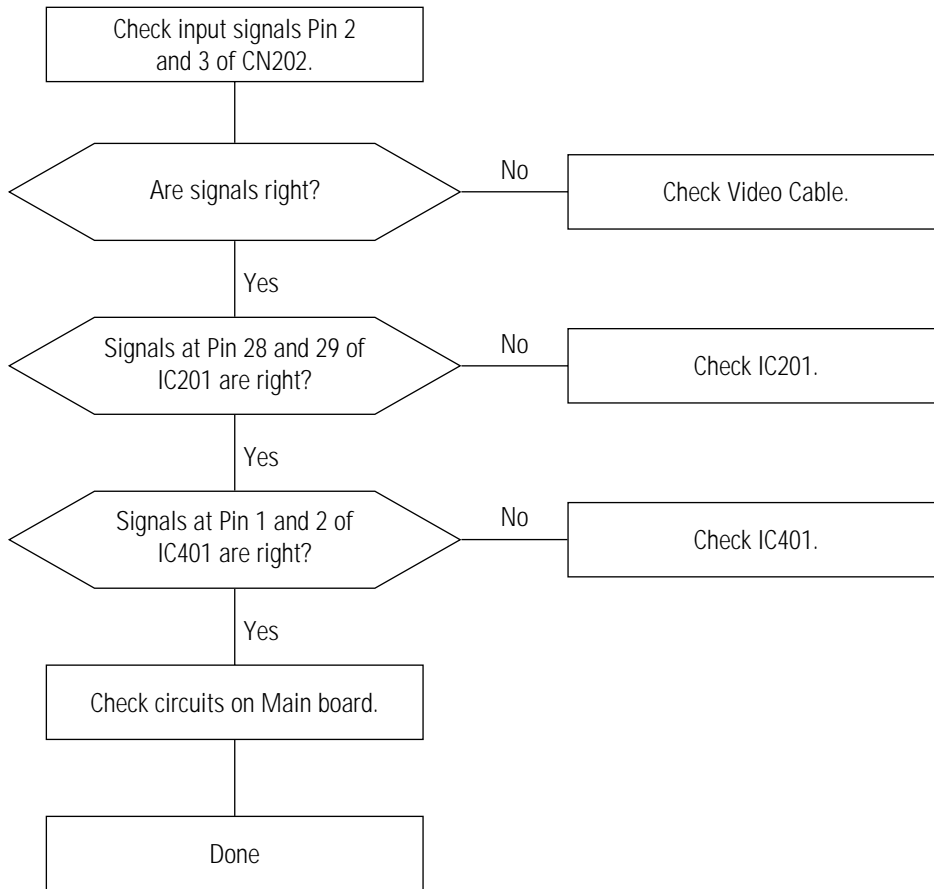

### 1-2-6 Misconvergence

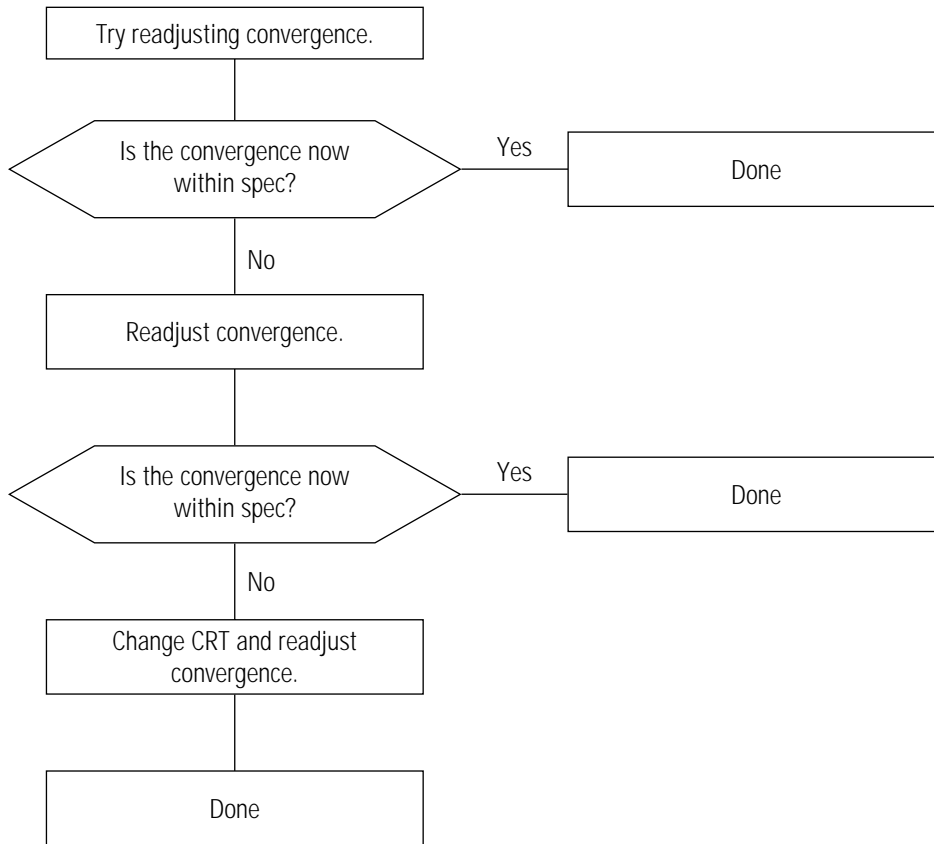

### 1-2-7 Poor Focus

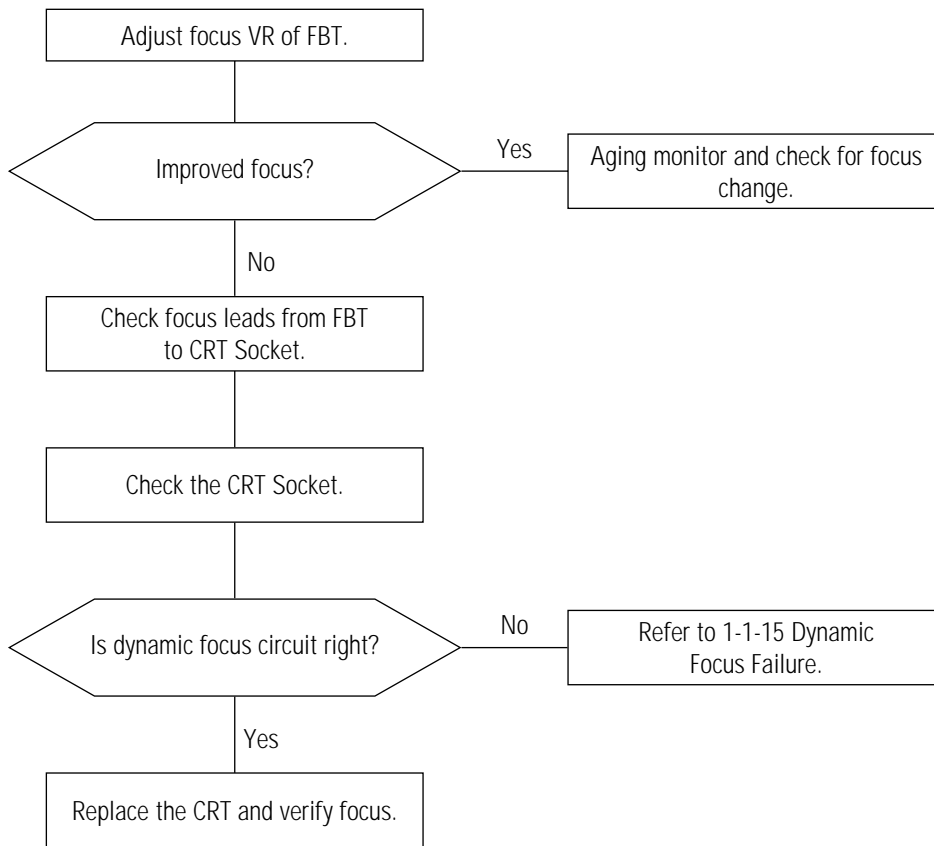

### 1-2-8 Purity Failure

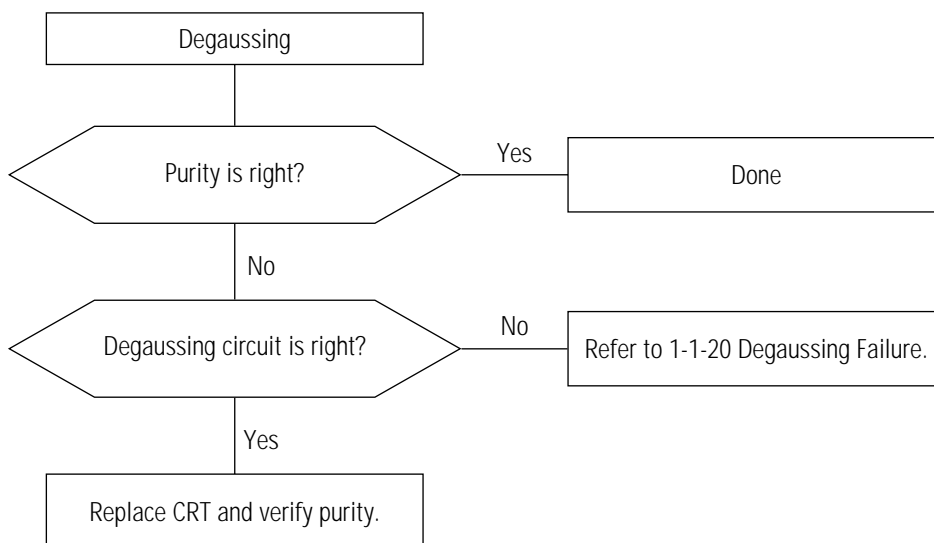

## 2 Electrical Parts List

### 2-1 Main PCB Parts

| Loc. No.  | Code No.    | Description         | Specification   | Remarks |
|-----------|-------------|---------------------|---|---------|
| B/PCB+LMF | 6003-000010 | SCREW-TAPTITE       | "BWH,+,B,M3,L10,ZPC(YEL),SWRCH1"  |         |
| BOTTOM    | 0403-000361 | DIODE-ZENER         | "UZ6.2BSB,6.2V,5.99-6.24V,500mW"  |         |
| C402      | 2305-000665 | "C-FILM,MPEF"       | "100nF,5%,63V,TP,7.5x4.0x5.0mm,"  |         |
| C409      | 2306-000147 | "C-FILM,MPPF"       | "1uF,5%,250V,BK,26x24x15,22.5mm"  |         |
| C420      | 2301-001306 | "C-FILM,PPF"        | "2.5NF,3%,1.6KV,TP,21.5X15.5X8.5MM,7.5"   | ▲       |
| C430      | 2306-000249 | "C-FILM,MPPF"       | "680nF,5%,250V,TP,26x20.5x12,20"  |         |
| C512      | 2201-000020 | "C-CERAMIC,DISC"    | "10nF,10%,1kV,Y5P,BK,18x5,10"   |         |
| C601      | 2301-001195 | "C-FILM,MPPF"       | "150nF,10%,275VAC,BK,26x16.5x7,"  |         |
| C602      | 2301-001195 | "C-FILM,MPPF"       | "150nF,10%,275VAC,BK,26x16.5x7,"  |         |
| C608      | 2401-003367 | C-AL                | "180uF,20%,400V,GP,BK,25x35mm,1"  |         |
| CIS       | 6501-000004 | CABLE TIE           | "DA-80,T1,W2.5,L80,NTR,NYLON66"   |         |
| CIS       | BH39-00016A | CBF-SIGNAL          | "-,1550MM,-,IVORY(IV01),2990,-"   |         |
| CIS       | BH68-00001A | LABEL/MARK-CDT      | "ART-PAPER 100G,-,WHT,BLK,-,ALL,CDT"  |         |
| CIS       | BH72-00025A | GUIDE-POWER         | "CDA4507,ABS+PC,5V,IV16,-,-"  |         |
| CIS       | BH72-00026A | SHAFT-POWER         | "CDA4507,ABS+PC,5V,IV16,-,-"  |         |
| CIS       | BH72-00078A | SHEET-LMF           | "DP17L,AL+PC,-,-,0.5,-"   |         |
| CIS       | BH73-60304C | RUBBER-SUPPORT      | "DP15LT,CR V0,GRAY,-,14*7*10,-,-"   |         |
| CIS       | BH75-00031A | UNIT/SHIELD-BOTTOM  | "CDB7907,SECC,-,-,-"  |         |
| CIS       | BH71-00002A | EARTH-PLATE/FRONT   | "CDB7907,STS 301,T0.15,-,-"   |         |
| CIS       | BH71-00008A | SHIELD-BOTTOM       | "CDA4507,SECC,T1.0,-,-"   |         |
| CN201     | 3711-003895 | CONNECTOR-HEADER    | "BOX,13P,1R,2mm,STRAIGHT,SN"  |         |
| CN202     | 3711-003873 | CONNECTOR-HEADER    | "BOX,7P,1R,2mm,STRAIGHT,SN"   |         |
| CN401     | 3711-003989 | CONNECTOR-HEADER    | "NOWALL,4P,1R,8mm,STRAIGHT,SN"  | ▲       |
| CN501+G2Y | BH39-00242A | CBF HARNESS         | "DB5907,U11032,U1/CSA,TP,290MM,RED,AWG22,YFH800,YPT-018,-,-,-,-,-,-,CBF-GND ASSY" |         |
| CN601     | 3721-001028 | PLUG-AC POWER       | "3P,-,-,NI"   | ▲       |
| CN603     | 3711-004454 | CONNECTOR-HEADER    | "NOWALL,2P,1R,10mm,STRAIGHT,SN"   |         |
| D406      | 0402-000178 | DIODE-RECTIFIER     | "3TH41A,1.5KV,3A,DO-201AD,BK"   |         |
| D409      | 0402-001256 | DIODE-RECTIFIER     | "SUF30JL,600V,3A,P600,BK"   |         |
| D414      | 0401-000005 | DIODE-SWITCHING     | "1N4148,100V,200MA,DO-35,TP"  |         |
| D415      | 0401-000005 | DIODE-SWITCHING     | "1N4148,100V,200MA,DO-35,TP"  |         |
| D601      | 0402-000103 | DIODE-BRIDGE        | "D2SBA60,600V,1.5A,SIP-4,ST"  |         |
| D609      | 0402-000005 | DIODE-RECTIFIER     | "31DF4,400V,3A,DO-201AD,BK"   |         |
| FBT       | 6502-000001 | CABLE CLAMP         | "DAWH-5NB,D15,L35,NTR,NYLON66"  |         |
| FUSE      | 3601-000004 | FUSE-CARTRIDGE      | "250V,3.15A,SLOW-BLOW,CERAMIC,5x20mm"   |         |
| IC201     | BH09-00031A | IC-MICOM            | "DP15H/17L,DM024 DP15H17L05,42P,DP15H17L05"                                       |         |
| IC401     | 1204-001724 | IC-DEF. PROCESSOR   | "TDA9113,SDIP,32P,400MIL,PLASTIC,16V,-,20to+70C,ST,H/V DEF. PROCESSOR"            |         |
| IC602     | 1203-000165 | IC-POSI.ADJUST REG. | "78R12,TO-220,3P,-,-,12V,-,0to+"  |         |
| IC604     | 1203-000001 | IC-POSI.FIXED REG.  | "7805,TO-220,3P,-,PLASTIC,4.8/5"  |         |
| JP60      | 2002-001056 | R-COMPOSITION       | "180Kohm,2%,1/4W,AA,TP,2.5x6.5mm"   |         |
| L401      | BH27-20345B | COIL-CHOKE          |   |         |
| L402      | BH27-00023A | COIL-CHOKE          | "120UH,+/-10%,DR1523(L-81,C:9.8),BK,-,-"  |         |
| L403      | BH27-20342U | COIL-CHOKE          | "-.8.2MH(250KHZ),10%,DR8*11,-,-,-,-,10.5OHM,-,-,-,BULK"                           |         |
| L601      | BH27-00007A | COIL-LINE FILTER    | "25MH MIN,-,SQE 2424,BULK,-,-"  |         |
| OP201     | 0601-001147 | LED                 | "ROUND,GRN,4.75mm,565nm"  |         |
| Q409      | 0505-001391 | FET-SILICON         | "IRF630M,N,200V,9A,0.4ohm,75W,TO-220"   |         |

| Loc. No.       | Code No.    | Description           | Specification  | Remarks |
|----------------|-------------|-----------------------|--|---------|
| Q410           | 0505-001391 | FET-SILICON           | "IRF630M,N,200V,9A,0.4ohm,75W,TO-220"                  |         |
| R417           | 2001-000290 | R-CARBON              | "10KOHM,5%,1/8W,AA,TP,1.8X3.2MM"                       |         |
| R527           | 2001-000864 | R-CARBON              | "56KOHM,5%,1/8W,AA,TP,1.8X3.2MM"                       |         |
| RL601          | 3501-001111 | RELAY-POWER           | "12Vdc,250mW,5A,1FormA,15mS,5mS"                       |         |
| S/BTM+PCB      | 6003-000010 | SCREW-TAPTITE         | "BWH,+ ,B,M3,L10,ZPC(YEL),SWRCH1"                      |         |
| SW401          | 3406-000002 | SWITCH-ROTARY         | "36Vdc,200mA,SP3T,-"                                   |         |
| SW601          | 3403-001050 | SWITCH-PUSH           | "30V,0.3A,SPDT,ON-OFF,PC BORD T"                       |         |
| T401           | BH26-00027A | TRANS-HOR.DRIVE       | "35.0MH,-,EI 1916,PL-3,-,310UH,-"                      | ⚠       |
| T402           | BH26-00028A | TRANS-H.LINEARITY     | "5.2UH,6P,DR1425(C:5.0),YL-81.5.2UH/68.0MH,-,HL-1425E" | ⚠       |
| T501           | BH26-00035A | TRANS-FBT             | "1.0MH,13P,FUR3658,HV45,-,-,FM1059,FEA831"             | ⚠       |
| T502           | BH26-00022A | TRANS-FOCUS           | "3.0MH,6P,EI 2218,SB-5S,3.0MH/470MH,25.0UH,EI-2218H"   | ⚠       |
| T601           | BH26-00020A | TRANS-POWER           | "390UH,16P,EER 3541,PL-3,PM2,SL1A,HU300A,-,6.0UH,-"    | ⚠       |
| T602           | BH26-30302S | TRANS-SYNC.           | "3-1(250UH),-,-,SB-5S,UU1116,3-"                       |         |
| TH601          | 1404-000002 | THERMISTOR-PTC        | "9ohm,20%,-,-,TR,RECT,-"                               |         |
| TH602          | 1404-001020 | THERMISTOR-NTC        | "8ohm,15%,-,-,17mW/C,BK"                               |         |
| VIDEO+MAIN GND | BH39-00024A | CBF-HARNESS           | "-,200MM,BLK,UL1015,AWG18,35068-9822"                  |         |
| BD301          | 3301-000011 | CORE-FERRITE BEAD     | "AA,3.5x1.0x5.7mm,1500,2375G"                          |         |
| BD401          | 3301-000011 | CORE-FERRITE BEAD     | "AA,3.5x1.0x5.7mm,1500,2375G"                          |         |
| BD402          | 3301-000011 | CORE-FERRITE BEAD     | "AA,3.5x1.0x5.7mm,1500,2375G"                          |         |
| BD601          | 3301-000011 | CORE-FERRITE BEAD     | "AA,3.5x1.0x5.7mm,1500,2375G"                          |         |
| BD602          | 3301-000011 | CORE-FERRITE BEAD     | "AA,3.5x1.0x5.7mm,1500,2375G"                          |         |
| BD603          | 3301-000011 | CORE-FERRITE BEAD     | "AA,3.5x1.0x5.7mm,1500,2375G"                          |         |
| C201           | 2401-000025 | C-AL                  | "100uF,20%,16V,GP,TP,6.3x11,5"                         |         |
| C202           | 2201-000389 | "C-CERAMIC,DISC"      | "0.022nF,5%,50V,NP0,TP,5x3,5"                          |         |
| C203           | 2201-000389 | "C-CERAMIC,DISC"      | "0.022nF,5%,50V,NP0,TP,5x3,5"                          |         |
| C204           | 2401-002075 | C-AL                  | "4.7uF,20%,50V,GP,TP,5x11,5"                           |         |
| C205           | 2401-000603 | C-AL                  | "1uF,20%,50V,GP,TP,5x11,5"                             |         |
| C206           | 2401-000050 | C-AL                  | "10uF,20%,16V,GP,TP,5x11,2.5"                          |         |
| C207           | 2401-002075 | C-AL                  | "4.7uF,20%,50V,GP,TP,5x11,5"                           |         |
| C209           | 2401-002075 | C-AL                  | "4.7uF,20%,50V,GP,TP,5x11,5"                           |         |
| C210           | 2401-002075 | C-AL                  | "4.7uF,20%,50V,GP,TP,5x11,5"                           |         |
| C211           | 2201-000146 | "C-CERAMIC,DISC"      | "0.1nF,5%,50V,SL,TP,5x3.5,5"                           |         |
| C212           | 2201-000017 | "C-CERAMIC,DISC"      | "1nF,10%,50V,Y5P,TP,5x3.5,5"                           |         |
| C213           | 2401-000029 | C-AL                  | "10uF,20%,100V,GP,TP,6.3x11,5"                         |         |
| C214           | 2401-000025 | C-AL                  | "100uF,20%,16V,GP,TP,6.3x11,5"                         |         |
| C215           | 2201-000146 | "C-CERAMIC,DISC"      | "0.1nF,5%,50V,SL,TP,5x3.5,5"                           |         |
| C216           | 2401-000603 | C-AL                  | "1uF,20%,50V,GP,TP,5x11,5"                             |         |
| C217           | 2202-002009 | "C-CERAMIC,MLC-AXIAL" | "100nF,+80-20%,50V,Y5V,TP,2.3X3"                       |         |
| C220           | 2401-000037 | C-AL                  | "470uF,20%,16V,GP,TP,8x11.5,5"                         |         |
| C221           | 2202-002009 | "C-CERAMIC,MLC-AXIAL" | "100nF,+80-20%,50V,Y5V,TP,2.3X3"                       |         |
| C222           | 2401-000050 | C-AL                  | "10uF,20%,16V,GP,TP,5x11,2.5"                          |         |
| C301           | 2301-000010 | "C-FILM,PEF"          | "100nF,5%,100V,TP,11.5x12.5mm,5"                       |         |
| C302           | 2305-001041 | "C-FILM,MPEF"         | "220nF,5%,63V,TP,7.5x4.5x13.5,5"                       |         |

| Loc. No. | Code No.    | Description           | Specification                         | Remarks |
|----------|-------------|-----------------------|---------------------------------------|---------|
| C305     | 2401-000037 | C-AL                  | "470uF,20%,16V,GP,TP,8x11.5,"         |         |
| C306     | 2401-000856 | C-AL                  | "220uF,20%,35V,WT,TP,10x20,5"         |         |
| C307     | 2305-000237 | "C-FILM,MPEF"         | "1uF,5%,63V,TP,7.5x15.5mm,5mm"        |         |
| C308     | 2301-000013 | "C-FILM,PEF"          | "4.7nF,5%,100V,TP,10.5x12.5x6.5"      |         |
| C309     | 2202-002008 | "C-CERAMIC,MLC-AXIAL" | "10nF,+80-20%,50V,Y5V,TP,2.3X3."      |         |
| C311     | 2301-001027 | "C-FILM,PEF"          | "15nF,10%,250V,TP,9.5x12x4.5,5m"      |         |
| C312     | 2401-001016 | C-AL                  | "3.3UF,20%,50V,BP,TP,5X11,5"          |         |
| C401     | 2301-000312 | "C-FILM,PEF"          | "8.2nF,5%,100V,TP,6x12.5mm,5mm"       |         |
| C403     | 2301-000148 | "C-FILM,PEF"          | "10nF,5%,100V,TP,7x3.2x7mm,5mm"       |         |
| C404     | 2301-000148 | "C-FILM,PEF"          | "10nF,5%,100V,TP,7x3.2x7mm,5mm"       |         |
| C405     | 2201-000823 | "C-CERAMIC,DISC"      | "0.27nF,5%,50V,SL,TP,8x3.5,5"         |         |
| C406     | 2301-000519 | "C-FILM,PEF"          | "3.3nF,5%,100V,TP,5.8x3x12.5,5m"      |         |
| C407     | 2401-000540 | C-AL                  | "150uF,20%,63V,LZ,TP,10x25,5"         |         |
| C408     | 2201-000469 | "C-CERAMIC,DISC"      | "0.33nF,10%,500V,Y5P,TP,5.5x3,5"      |         |
| C410     | 2401-000025 | C-AL                  | "100uF,20%,16V,GP,TP,6.3x11,5"        |         |
| C411     | 2301-000005 | "C-FILM,PEF"          | "33nF,5%,100V,TP,5.8x12.5x3,5"        |         |
| C412     | 2301-000148 | "C-FILM,PEF"          | "10nF,5%,100V,TP,7x3.2x7mm,5mm"       |         |
| C413     | 2401-001012 | C-AL                  | "3.3UF,20%,50V,BP,TP,16X25,7.5"       |         |
| C414     | 2401-001334 | C-AL                  | "470nF,20%,50V,GP,TP,5x11,2.5"        |         |
| C415     | 2401-001218 | C-AL                  | "4.7uF,20%,100V,WT,TP,5x11,5"         |         |
| C416     | 2301-000010 | "C-FILM,PEF"          | "100nF,5%,100V,TP,11.5x12.5mm,5"      |         |
| C417     | 2301-000148 | "C-FILM,PEF"          | "10nF,5%,100V,TP,7x3.2x7mm,5mm"       |         |
| C419     | 2301-001305 | "C-FILM,PPF"          | "2.2NF,3%,1.6KV,TP,22X15.5X8.5MM,7.5" |         |
| C421     | 2303-001029 | "C-FILM,PPF"          | "5.2nF,5%,630V,TP,19x7x13,7.5"        |         |
| C423     | 2401-000603 | C-AL                  | "1uF,20%,50V,GP,TP,5x11,5"            |         |
| C425     | 2306-000119 | "C-FILM,MPPF"         | "100nF,5%,250V,TP,19x14.5x6.5,7"      |         |
| C426     | 2401-000603 | C-AL                  | "1uF,20%,50V,GP,TP,5x11,5"            |         |
| C427     | 2306-000164 | "C-FILM,MPPF"         | "220nF,5%,250V,TP,19x22x10,7.5m"      |         |
| C429     | 2401-000603 | C-AL                  | "1uF,20%,50V,GP,TP,5x11,5"            |         |
| C431     | 2306-000179 | "C-FILM,MPPF"         | "300nF,5%,250V,TP,20x18.5x10.5,"      |         |
| C432     | 2305-001033 | "C-FILM,MPEF"         | "15nF,10%,250V,TP,13X9.0X4.5mm,"      |         |
| C433     | 2305-001003 | "C-FILM,MPEF"         | "10nF,5%,250V,TP,13x4.5x9mm,7.5"      |         |
| C434     | 2401-001016 | C-AL                  | "3.3UF,20%,50V,BP,TP,5X11,5"          |         |
| C435     | 2201-000469 | "C-CERAMIC,DISC"      | "0.33nF,10%,500V,Y5P,TP,5.5x3,5"      |         |
| C501     | 2301-000016 | "C-FILM,PEF"          | "22nF,5%,100V,TP,7.2x4.5x9.0mm,"      |         |
| C502     | 2301-000016 | "C-FILM,PEF"          | "22nF,5%,100V,TP,7.2x4.5x9.0mm,"      |         |
| C503     | 2401-000050 | C-AL                  | "10uF,20%,16V,GP,TP,5x11,2.5"         |         |
| C504     | 2301-000004 | "C-FILM,PEF"          | "2.2nF,5%,100V,TP,5.5X10X2.9,5m"      |         |
| C505     | 2401-000059 | C-AL                  | "220nF,20%,50V,GP,-,5x11,5"           |         |
| C507     | 2201-000291 | "C-CERAMIC,DISC"      | "1nF,10%,500V,Y5P,TP,7.5x3.5,5"       |         |
| C508     | 2401-002267 | C-AL                  | "2.2uF,20%,250V,GP,TP,8x11.5,5"       |         |
| C509     | 2401-002267 | C-AL                  | "2.2uF,20%,250V,GP,TP,8x11.5,5"       |         |
| C510     | 2301-000005 | "C-FILM,PEF"          | "33nF,5%,100V,TP,5.8x12.5x3,5"        |         |
| C511     | 2301-000519 | "C-FILM,PEF"          | "3.3nF,5%,100V,TP,5.8x3x12.5,5m"      |         |
| C513     | 2201-000291 | "C-CERAMIC,DISC"      | "1nF,10%,500V,Y5P,TP,7.5x3.5,5"       |         |
| C514     | 2401-001334 | C-AL                  | "470nF,20%,50V,GP,TP,5x11,2.5"        |         |
| C515     | 2301-000148 | "C-FILM,PEF"          | "10nF,5%,100V,TP,7x3.2x7mm,5mm"       | ⚠       |



2 Electrical Parts List

| Loc. No. | Code No.    | Description           | Specification                         | Remarks |
|----------|-------------|-----------------------|---------------------------------------|---------|
| C551     | 2401-000050 | C-AL                  | "10uF,20%,16V,GP,TP,5x11,2,5"         |         |
| C552     | 2201-000132 | "C-CERAMIC,DISC"      | "0.1nF,10%,500V,Y5P,TP,6.5x3,5"       |         |
| C603     | 2201-000023 | "C-CERAMIC,DISC"      | "2.2nF,20%,125V,Y5U,TP,11x7,5"        |         |
| C604     | 2201-000023 | "C-CERAMIC,DISC"      | "2.2nF,20%,125V,Y5U,TP,11x7,5"        | ⚠       |
| C605     | 2305-001041 | "C-FILM,MPEF"         | "220nF,5%,63V,TP,7.5x4.5x13.5,5"      |         |
| C607     | 2202-002009 | "C-CERAMIC,MLC-AXIAL" | "100nF,+80-20%,50V,Y5V,TP,2.3X3"      |         |
| C609     | 2401-000971 | C-AL                  | "22uF,20%,50V,WT,TP,6x11mm,5mm"       |         |
| C610     | 2301-000284 | "C-FILM,PEF"          | "47nF,5%,100V,TP,8.5x12.5mm,5mm"      |         |
| C611     | 2401-000613 | C-AL                  | "1uF,20%,50V,WT,TP,5x11,5"            |         |
| C612     | 2401-000613 | C-AL                  | "1uF,20%,50V,WT,TP,5x11,5"            |         |
| C613     | 2201-000012 | "C-CERAMIC,DISC"      | "0.22nF,10%,1kV,Y5P,TP,6.3x5,5"       |         |
| C614     | 2201-000019 | "C-CERAMIC,DISC"      | "10nF,+80-20%,500V,Y5V,TP,13.5x4mm,5" |         |
| C615     | 2201-000291 | "C-CERAMIC,DISC"      | "1nF,10%,500V,Y5P,TP,7.5x3.5,5"       |         |
| C616     | 2201-000023 | "C-CERAMIC,DISC"      | "2.2nF,20%,125V,Y5U,TP,11x7,5"        | ⚠       |
| C617     | 2201-000023 | "C-CERAMIC,DISC"      | "2.2nF,20%,125V,Y5U,TP,11x7,5"        | ⚠       |
| C618     | 2401-000039 | C-AL                  | "1000uF,20%,16V,GP,TP,10x16,5"        |         |
| C619     | 2201-000469 | "C-CERAMIC,DISC"      | "0.33nF,10%,500V,Y5P,TP,5.5x3,5"      |         |
| C620     | 2401-000540 | C-AL                  | "150uF,20%,63V,LZ,TP,10x25,5"         |         |
| C621     | 2401-001551 | C-AL                  | "47uF,20%,35V,GP,TP,6.3x11,5"         |         |
| C622     | 2401-000039 | C-AL                  | "1000uF,20%,16V,GP,TP,10x16,5"        |         |
| C623     | 2401-000039 | C-AL                  | "1000uF,20%,16V,GP,TP,10x16,5"        |         |
| C626     | 2401-000025 | C-AL                  | "100uF,20%,16V,GP,TP,6.3x11,5"        |         |
| C627     | 2401-000292 | C-AL                  | "100uF,20%,16V,WT,TP,8x11.5mm,5"      |         |
| C630     | 2401-001561 | C-AL                  | "47uF,20%,35V,WT,TP,8x11.5,5"         |         |
| C631     | 2202-002009 | "C-CERAMIC,MLC-AXIAL" | "100nF,+80-20%,50V,Y5V,TP,2.3X3"      |         |
| CN304    | 3711-000197 | CONNECTOR-HEADER      | "1WALL,3P,1R,2.5mm,STRAIGHT,SN"       |         |
| D301     | 0402-000274 | DIODE-RECTIFIER       | "UF4004,400V,1A,DO-41,TP"             |         |
| D401     | 0402-000274 | DIODE-RECTIFIER       | "UF4004,400V,1A,DO-41,TP"             |         |
| D402     | 0402-000006 | DIODE-RECTIFIER       | "1N4007GP,1000V,1A,DO-41,TP"          |         |
| D403     | 0402-000006 | DIODE-RECTIFIER       | "1N4007GP,1000V,1A,DO-41,TP"          |         |
| D404     | 0402-000006 | DIODE-RECTIFIER       | "1N4007GP,1000V,1A,DO-41,TP"          |         |
| D405     | 0402-000274 | DIODE-RECTIFIER       | "UF4004,400V,1A,DO-41,TP"             |         |
| D407     | 0402-001118 | DIODE-RECTIFIER       | "UF1G,400V,1.2A,DO-204AL,TP"          |         |
| D410     | 0402-000546 | DIODE-RECTIFIER       | "TVR10G,400V,1.0A,DO-41,TP"           |         |
| D411     | 0402-000546 | DIODE-RECTIFIER       | "TVR10G,400V,1.0A,DO-41,TP"           |         |
| D412     | 0402-000546 | DIODE-RECTIFIER       | "TVR10G,400V,1.0A,DO-41,TP"           |         |
| D413     | 0402-000546 | DIODE-RECTIFIER       | "TVR10G,400V,1.0A,DO-41,TP"           |         |
| D420     | 0401-000005 | DIODE-SWITCHING       | "1N4148,100V,200MA,DO-35,TP"          |         |
| D421     | 0401-000005 | DIODE-SWITCHING       | "1N4148,100V,200MA,DO-35,TP"          |         |
| D422     | 0401-000004 | DIODE-SWITCHING       | "1SS244,250V,200mA,DO-34,TP"          |         |
| D501     | 0401-000005 | DIODE-SWITCHING       | "1N4148,100V,200MA,DO-35,TP"          |         |
| D502     | 0402-000017 | DIODE-RECTIFIER       | "RGP02-12,1200V,0.5A,DO-204AL,T"      |         |
| D503     | 0402-000017 | DIODE-RECTIFIER       | "RGP02-12,1200V,0.5A,DO-204AL,T"      |         |

| Loc. No. | Code No.    | Description     | Specification                    | Remarks   |
|----------|-------------|-----------------|----------------------------------|---|
| D504     | 0402-000017 | DIODE-RECTIFIER | "RGP02-12,1200V,0.5A,DO-204AL,T" |   |
| D505     | 0401-000004 | DIODE-SWITCHING | "1SS244,250V,200mA,DO-34,TP"     |   |
| D506     | 0402-000546 | DIODE-RECTIFIER | "TVR10G,400V,1.0A,DO-41,TP"      |   |
| D507     | 0401-000005 | DIODE-SWITCHING | "1N4148,100V,200MA,DO-35,TP"     |   |
| D508     | 0401-000005 | DIODE-SWITCHING | "1N4148,100V,200MA,DO-35,TP"     |   |
| D509     | 0401-000005 | DIODE-SWITCHING | "1N4148,100V,200MA,DO-35,TP"     |   |
| D510     | 0401-000005 | DIODE-SWITCHING | "1N4148,100V,200MA,DO-35,TP"     |   |
| D511     | 0401-000005 | DIODE-SWITCHING | "1N4148,100V,200MA,DO-35,TP"     |   |
| D512     | 0401-000005 | DIODE-SWITCHING | "1N4148,100V,200MA,DO-35,TP"     |   |
| D513     | 0401-000005 | DIODE-SWITCHING | "1N4148,100V,200MA,DO-35,TP"     |   |
| D514     | 0402-000017 | DIODE-RECTIFIER | "RGP02-12,1200V,0.5A,DO-204AL,T" |   |
| D602     | 0401-000005 | DIODE-SWITCHING | "1N4148,100V,200MA,DO-35,TP"     |   |
| D604     | 0402-000012 | DIODE-RECTIFIER | "UF4007,1KV,1A,DO-41,TP"         |   |
| D605     | 0402-000012 | DIODE-RECTIFIER | "UF4007,1KV,1A,DO-41,TP"         |   |
| D606     | 0402-000546 | DIODE-RECTIFIER | "TVR10G,400V,1.0A,DO-41,TP"      |   |
| D607     | 0401-000005 | DIODE-SWITCHING | "1N4148,100V,200MA,DO-35,TP"     |   |
| D608     | 0402-000274 | DIODE-RECTIFIER | "UF4004,400V,1A,DO-41,TP"        |   |
| D610     | 0402-000012 | DIODE-RECTIFIER | "UF4007,1KV,1A,DO-41,TP"         |   |
| D611     | 0402-001118 | DIODE-RECTIFIER | "UF1G,400V,1.2A,DO-204AL,TP"     |   |
| D612     | 0402-000546 | DIODE-RECTIFIER | "TVR10G,400V,1.0A,DO-41,TP"      |   |
| D614     | 0402-000274 | DIODE-RECTIFIER | "UF4004,400V,1A,DO-41,TP"        |   |
| D615     | 0401-000005 | DIODE-SWITCHING | "1N4148,100V,200MA,DO-35,TP"     |   |
| D616     | 0401-000005 | DIODE-SWITCHING | "1N4148,100V,200MA,DO-35,TP"     |   |
| EY301    | 6042-000001 | EYELET          | "ID2.2,OD2.7,L3.1,SN,BSS3-E/EH"  |   |
| EY302    | 6042-000001 | EYELET          | "ID2.2,OD2.7,L3.1,SN,BSS3-E/EH"  |   |
| EY401    | 6042-000002 | EYELET          | "ID1.5,OD2,L3.1,SN,BSS3-E/EH"    |   |
| EY402    | 6042-000002 | EYELET          | "ID1.5,OD2,L3.1,SN,BSS3-E/EH"    |   |
| EY403    | 6042-000002 | EYELET          | "ID1.5,OD2,L3.1,SN,BSS3-E/EH"    |   |
| EY501    | 6042-000001 | EYELET          | "ID2.2,OD2.7,L3.1,SN,BSS3-E/EH"  |   |
| EY502    | 6042-000001 | EYELET          | "ID2.2,OD2.7,L3.1,SN,BSS3-E/EH"  |   |
| EY503    | 6042-000001 | EYELET          | "ID2.2,OD2.7,L3.1,SN,BSS3-E/EH"  |   |
| EY504    | 6042-000002 | EYELET          | "ID1.5,OD2,L3.1,SN,BSS3-E/EH"    |   |
| EY505    | 6042-000002 | EYELET          | "ID1.5,OD2,L3.1,SN,BSS3-E/EH"    |   |
| EY506    | 6042-000002 | EYELET          | "ID1.5,OD2,L3.1,SN,BSS3-E/EH"    |   |
| EY507    | 6042-000002 | EYELET          | "ID1.5,OD2,L3.1,SN,BSS3-E/EH"    |   |
| EY508    | 6042-000002 | EYELET          | "ID1.5,OD2,L3.1,SN,BSS3-E/EH"    |   |
| EY601    | 6042-000001 | EYELET          | "ID2.2,OD2.7,L3.1,SN,BSS3-E/EH"  |   |
| EY602    | 6042-000001 | EYELET          | "ID2.2,OD2.7,L3.1,SN,BSS3-E/EH"  |   |
| EY603    | 6042-000001 | EYELET          | "ID2.2,OD2.7,L3.1,SN,BSS3-E/EH"  |   |
| EY604    | 6042-000001 | EYELET          | "ID2.2,OD2.7,L3.1,SN,BSS3-E/EH"  |   |
| EY605    | 6042-000001 | EYELET          | "ID2.2,OD2.7,L3.1,SN,BSS3-E/EH"  |   |
| EY606    | 6042-000001 | EYELET          | "ID2.2,OD2.7,L3.1,SN,BSS3-E/EH"  |   |
| EY607    | 6042-000002 | EYELET          | "ID1.5,OD2,L3.1,SN,BSS3-E/EH"    |   |
| EY608    | 6042-000002 | EYELET          | "ID1.5,OD2,L3.1,SN,BSS3-E/EH"    |   |
| EY609    | 6042-000002 | EYELET          | "ID1.5,OD2,L3.1,SN,BSS3-E/EH"    |   |
| FH1      | 3602-000001 | FUSE-CLIP       | "-,30mohm"                       |   |
| GT603    | BH71-40300A | PIN-HINGE       | "-,BRASS,D2.36,SN,HEAT/SINK"     |  |

| Loc. No. | Code No.    | Description | Specification                    | Remarks |
|----------|-------------|-------------|----------------------------------|---------|
| GT604    | BH71-40300A | PIN-HINGE   | "-,BRASS,D2.36,SN,HEAT/SINK"     |         |
| IC202    | 1103-000156 | IC-EEPROM   | "24C04,512x8BIT,DIP,8P,300MIL,1" |         |
| IC603    | 1201-000229 | IC-OP AMP   | "324,DIP,14P,300MIL,QUAD,100V/m" |         |
| IC605    | 1203-000495 | IC-RESET    | "7045,T0-92,3P,-,PLASTIC,4.3/4." |         |
| JP1      | BH39-40305U | CBF HARNESS | "52MM,AWG22(0.6PI),-,-,AWG22(0." |         |
| JP10     | BH39-40305U | CBF HARNESS | "52MM,AWG22(0.6PI),-,-,AWG22(0." |         |
| JP11     | BH39-40305U | CBF HARNESS | "52MM,AWG22(0.6PI),-,-,AWG22(0." |         |
| JP12     | BH39-40305U | CBF HARNESS | "52MM,AWG22(0.6PI),-,-,AWG22(0." |         |
| JP13     | BH39-40305U | CBF HARNESS | "52MM,AWG22(0.6PI),-,-,AWG22(0." |         |
| JP14     | BH39-40305U | CBF HARNESS | "52MM,AWG22(0.6PI),-,-,AWG22(0." |         |
| JP16     | BH39-40305U | CBF HARNESS | "52MM,AWG22(0.6PI),-,-,AWG22(0." |         |
| JP17     | BH39-40305U | CBF HARNESS | "52MM,AWG22(0.6PI),-,-,AWG22(0." |         |
| JP18     | BH39-40305U | CBF HARNESS | "52MM,AWG22(0.6PI),-,-,AWG22(0." |         |
| JP19     | BH39-40305U | CBF HARNESS | "52MM,AWG22(0.6PI),-,-,AWG22(0." |         |
| JP2      | BH39-40305U | CBF HARNESS | "52MM,AWG22(0.6PI),-,-,AWG22(0." |         |
| JP20     | BH39-40305U | CBF HARNESS | "52MM,AWG22(0.6PI),-,-,AWG22(0." |         |
| JP21     | BH39-40305U | CBF HARNESS | "52MM,AWG22(0.6PI),-,-,AWG22(0." |         |
| JP22     | BH39-40305U | CBF HARNESS | "52MM,AWG22(0.6PI),-,-,AWG22(0." |         |
| JP23     | BH39-40305U | CBF HARNESS | "52MM,AWG22(0.6PI),-,-,AWG22(0." |         |
| JP24     | BH39-40305U | CBF HARNESS | "52MM,AWG22(0.6PI),-,-,AWG22(0." |         |
| JP25     | BH39-40305U | CBF HARNESS | "52MM,AWG22(0.6PI),-,-,AWG22(0." |         |
| JP26     | BH39-40305U | CBF HARNESS | "52MM,AWG22(0.6PI),-,-,AWG22(0." |         |
| JP27     | BH39-40305U | CBF HARNESS | "52MM,AWG22(0.6PI),-,-,AWG22(0." |         |
| JP29     | BH39-40305U | CBF HARNESS | "52MM,AWG22(0.6PI),-,-,AWG22(0." |         |
| JP3      | BH39-40305U | CBF HARNESS | "52MM,AWG22(0.6PI),-,-,AWG22(0." |         |
| JP30     | BH39-40305U | CBF HARNESS | "52MM,AWG22(0.6PI),-,-,AWG22(0." |         |
| JP31     | BH39-40305U | CBF HARNESS | "52MM,AWG22(0.6PI),-,-,AWG22(0." |         |
| JP32     | BH39-40305U | CBF HARNESS | "52MM,AWG22(0.6PI),-,-,AWG22(0." |         |
| JP33     | BH39-40305U | CBF HARNESS | "52MM,AWG22(0.6PI),-,-,AWG22(0." |         |
| JP34     | BH39-40305U | CBF HARNESS | "52MM,AWG22(0.6PI),-,-,AWG22(0." |         |
| JP35     | BH39-40305U | CBF HARNESS | "52MM,AWG22(0.6PI),-,-,AWG22(0." |         |
| JP36     | BH39-40305U | CBF HARNESS | "52MM,AWG22(0.6PI),-,-,AWG22(0." |         |
| JP37     | BH39-40305U | CBF HARNESS | "52MM,AWG22(0.6PI),-,-,AWG22(0." |         |
| JP38     | BH39-40305U | CBF HARNESS | "52MM,AWG22(0.6PI),-,-,AWG22(0." |         |
| JP39     | BH39-40305U | CBF HARNESS | "52MM,AWG22(0.6PI),-,-,AWG22(0." |         |
| JP4      | BH39-40305U | CBF HARNESS | "52MM,AWG22(0.6PI),-,-,AWG22(0." |         |
| JP40     | BH39-40305U | CBF HARNESS | "52MM,AWG22(0.6PI),-,-,AWG22(0." |         |
| JP41     | BH39-40305U | CBF HARNESS | "52MM,AWG22(0.6PI),-,-,AWG22(0." |         |
| JP42     | BH39-40305U | CBF HARNESS | "52MM,AWG22(0.6PI),-,-,AWG22(0." |         |
| JP44     | BH39-40305U | CBF HARNESS | "52MM,AWG22(0.6PI),-,-,AWG22(0." |         |
| JP45     | BH39-40305U | CBF HARNESS | "52MM,AWG22(0.6PI),-,-,AWG22(0." |         |
| JP46     | BH39-40305U | CBF HARNESS | "52MM,AWG22(0.6PI),-,-,AWG22(0." |         |
| JP47     | BH39-40305U | CBF HARNESS | "52MM,AWG22(0.6PI),-,-,AWG22(0." |         |
| JP48     | BH39-40305U | CBF HARNESS | "52MM,AWG22(0.6PI),-,-,AWG22(0." |         |
| JP49     | BH39-40305U | CBF HARNESS | "52MM,AWG22(0.6PI),-,-,AWG22(0." |         |
| JP5      | BH39-40305U | CBF HARNESS | "52MM,AWG22(0.6PI),-,-,AWG22(0." |         |
| JP50     | BH39-40305U | CBF HARNESS | "52MM,AWG22(0.6PI),-,-,AWG22(0." |         |

| Loc. No. | Code No.    | Description     | Specification                          | Remarks |
|----------|-------------|-----------------|--|---------|
| JP55     | BH39-40305U | CBF HARNESS     | "52MM,AWG22(0.6PI),-,-,AWG22(0."       |         |
| JP56     | BH39-40305U | CBF HARNESS     | "52MM,AWG22(0.6PI),-,-,AWG22(0."       |         |
| JP57     | BH39-40305U | CBF HARNESS     | "52MM,AWG22(0.6PI),-,-,AWG22(0."       |         |
| JP58     | BH39-40305U | CBF HARNESS     | "52MM,AWG22(0.6PI),-,-,AWG22(0."       |         |
| JP62     | BH39-40305U | CBF HARNESS     | "52MM,AWG22(0.6PI),-,-,AWG22(0."       |         |
| JP63     | BH39-40305U | CBF HARNESS     | "52MM,AWG22(0.6PI),-,-,AWG22(0."       |         |
| JP64     | BH39-40305U | CBF HARNESS     | "52MM,AWG22(0.6PI),-,-,AWG22(0."       |         |
| JP65     | BH39-40305U | CBF HARNESS     | "52MM,AWG22(0.6PI),-,-,AWG22(0."       |         |
| JP66     | BH39-40305U | CBF HARNESS     | "52MM,AWG22(0.6PI),-,-,AWG22(0."       |         |
| JP67     | BH39-40305U | CBF HARNESS     | "52MM,AWG22(0.6PI),-,-,AWG22(0."       |         |
| JP68     | BH39-40305U | CBF HARNESS     | "52MM,AWG22(0.6PI),-,-,AWG22(0."       |         |
| JP69     | BH39-40305U | CBF HARNESS     | "52MM,AWG22(0.6PI),-,-,AWG22(0."       |         |
| JP70     | BH39-40305U | CBF HARNESS     | "52MM,AWG22(0.6PI),-,-,AWG22(0."       |         |
| JP71     | BH39-40305U | CBF HARNESS     | "52MM,AWG22(0.6PI),-,-,AWG22(0."       |         |
| JP72     | BH39-40305U | CBF HARNESS     | "52MM,AWG22(0.6PI),-,-,AWG22(0."       |         |
| JP8      | BH39-40305U | CBF HARNESS     | "52MM,AWG22(0.6PI),-,-,AWG22(0."       |         |
| JP9      | BH39-40305U | CBF HARNESS     | "52MM,AWG22(0.6PI),-,-,AWG22(0."       |         |
| MP2.6    | BH41-00012A | P.C.B-MAIN      | "-,FR-1,-,-,-"                         |         |
| Q301     | 0501-000586 | TR-SMALL SIGNAL | "KSC945,NPN,250mW,TO-92,TP,120-"       |         |
| Q302     | 0501-000303 | TR-SMALL SIGNAL | "KSA733,PNP,250mW,TO-92,TP,120-"       |         |
| Q303     | 0501-000413 | TR-SMALL SIGNAL | "KSP44,NPN,625mW,TO-92,-,50-200"       |         |
| Q401     | 0501-000122 | TR-SMALL SIGNAL | "2N3904,NPN,625mW,TO-92,TP,100-"       |         |
| Q403     | 0501-000372 | TR-SMALL SIGNAL | "KSC2383-Y,NPN,900mW,TO-92L,-,1"       |         |
| Q405     | 0501-000303 | TR-SMALL SIGNAL | "KSA733,PNP,250mW,TO-92,TP,120-"       |         |
| Q406     | 0501-000303 | TR-SMALL SIGNAL | "KSA733,PNP,250mW,TO-92,TP,120-"       |         |
| Q407     | 0501-000010 | TR-SMALL SIGNAL | "KSC1008,NPN,800mW,TO-92,TP,120"       |         |
| Q412     | 0501-000404 | TR-SMALL SIGNAL | "KSD1616-Y,NPN,750mW,TO-92,TP,1"       |         |
| Q413     | 0501-000321 | TR-SMALL SIGNAL | "KSB1116-Y,PNP,0.75W,TO-92,-,13"       |         |
| Q414     | 0501-000586 | TR-SMALL SIGNAL | "KSC945,NPN,250mW,TO-92,TP,120-"       |         |
| Q415     | 0501-000586 | TR-SMALL SIGNAL | "KSC945,NPN,250mW,TO-92,TP,120-"       |         |
| Q416     | 0501-000586 | TR-SMALL SIGNAL | "KSC945,NPN,250mW,TO-92,TP,120-"       |         |
| Q501     | 0501-000143 | TR-SMALL SIGNAL | "2N6520,PNP,625mW,TO-92,-,30-20"       |         |
| Q502     | 0501-000143 | TR-SMALL SIGNAL | "2N6520,PNP,625mW,TO-92,-,30-20"       |         |
| Q503     | 0501-000303 | TR-SMALL SIGNAL | "KSA733,PNP,250mW,TO-92,TP,120-"       |         |
| Q551     | 0501-000413 | TR-SMALL SIGNAL | "KSP44,NPN,625mW,TO-92,-,50-200"       |         |
| Q601     | 0501-000586 | TR-SMALL SIGNAL | "KSC945,NPN,250mW,TO-92,TP,120-"       |         |
| Q602     | 0501-000122 | TR-SMALL SIGNAL | "2N3904,NPN,625mW,TO-92,TP,100-"       |         |
| Q604     | 0501-000404 | TR-SMALL SIGNAL | "KSD1616-Y,NPN,750mW,TO-92,TP,1"       |         |
| Q608     | 0501-000010 | TR-SMALL SIGNAL | "KSC1008,NPN,800mW,TO-92,TP,120"       |         |
| Q609     | 0501-002228 | TR-SMALL SIGNAL | "KTA1281,PNP,1000MW,TO-92L,TP,120-240" |         |
| Q610     | 0501-000586 | TR-SMALL SIGNAL | "KSC945,NPN,250mW,TO-92,TP,120-"       |         |
| R200     | 2001-000869 | R-CARBON        | "56OHM,5%,1/8W,AA,TP,1.8X3.2MM"        |         |
| R201     | 2001-000786 | R-CARBON        | "47KOHM,5%,1/8W,AA,TP,1.8X3.2MM"       |         |
| R202     | 2001-000290 | R-CARBON        | "10KOHM,5%,1/8W,AA,TP,1.8X3.2MM"       |         |
| R203     | 2001-000734 | R-CARBON        | "4.7KOHM,5%,1/8W,AA,TP,1.8X3.2MM"      |         |
| R204     | 2001-000734 | R-CARBON        | "4.7KOHM,5%,1/8W,AA,TP,1.8X3.2MM"      |         |

## 2 Electrical Parts List

| Loc. No. | Code No.    | Description | Specification                     | Remarks |
|----------|-------------|-------------|-----------------------------------|---------|
| R206     | 2001-000515 | R-CARBON    | "220OHM,5%,1/8W,AA,TP,1.8X3.2MM"  |         |
| R207     | 2001-000869 | R-CARBON    | "56OHM,5%,1/8W,AA,TP,1.8X3.2MM"   |         |
| R208     | 2001-000869 | R-CARBON    | "56OHM,5%,1/8W,AA,TP,1.8X3.2MM"   |         |
| R209     | 2001-000734 | R-CARBON    | "4.7KOHM,5%,1/8W,AA,TP,1.8X3.2MM" |         |
| R210     | 2001-000472 | R-CARBON    | "2.7KOHM,5%,1/8W,AA,TP,1.8X3.2MM" |         |
| R211     | 2001-000904 | R-CARBON    | "620OHM,5%,1/8W,AA,TP,1.8X3.2MM"  |         |
| R212     | 2001-000613 | R-CARBON    | "3.9KOHM,5%,1/8W,AA,TP,1.8X3.2MM" |         |
| R213     | 2001-000429 | R-CARBON    | "1KOHM,5%,1/8W,AA,TP,1.8X3.2MM"   |         |
| R214     | 2001-000429 | R-CARBON    | "1KOHM,5%,1/8W,AA,TP,1.8X3.2MM"   |         |
| R215     | 2001-000281 | R-CARBON    | "100OHM,5%,1/8W,AA,TP,1.8X3.2MM"  |         |
| R216     | 2001-000281 | R-CARBON    | "100OHM,5%,1/8W,AA,TP,1.8X3.2MM"  |         |
| R217     | 2001-000281 | R-CARBON    | "100OHM,5%,1/8W,AA,TP,1.8X3.2MM"  |         |
| R218     | 2001-000281 | R-CARBON    | "100OHM,5%,1/8W,AA,TP,1.8X3.2MM"  |         |
| R219     | 2001-000290 | R-CARBON    | "10KOHM,5%,1/8W,AA,TP,1.8X3.2MM"  |         |
| R220     | 2001-000281 | R-CARBON    | "100OHM,5%,1/8W,AA,TP,1.8X3.2MM"  |         |
| R221     | 2001-000734 | R-CARBON    | "4.7KOHM,5%,1/8W,AA,TP,1.8X3.2MM" |         |
| R222     | 2001-000734 | R-CARBON    | "4.7KOHM,5%,1/8W,AA,TP,1.8X3.2MM" |         |
| R223     | 2001-000038 | R-CARBON    | "390OHM,5%,1/4W,AA,TP,2.4X6.4MM"  |         |
| R224     | 2001-000869 | R-CARBON    | "56OHM,5%,1/8W,AA,TP,1.8X3.2MM"   |         |
| R225     | 2001-000869 | R-CARBON    | "56OHM,5%,1/8W,AA,TP,1.8X3.2MM"   |         |
| R229     | 2001-000281 | R-CARBON    | "100OHM,5%,1/8W,AA,TP,1.8X3.2MM"  |         |
| R230     | 2001-000290 | R-CARBON    | "10KOHM,5%,1/8W,AA,TP,1.8X3.2MM"  |         |
| R231     | 2001-000241 | R-CARBON    | "1.5KOHM,5%,1/8W,AA,TP,1.8X3.2MM" |         |
| R232     | 2001-000812 | R-CARBON    | "5.6KOHM,5%,1/8W,AA,TP,1.8X3.2MM" |         |
| R233     | 2001-000331 | R-CARBON    | "12KOHM,5%,1/8W,AA,TP,1.8X3.2MM"  |         |
| R234     | 2001-000563 | R-CARBON    | "27KOHM,5%,1/8W,AA,TP,1.8X3.2MM"  |         |
| R235     | 2001-000472 | R-CARBON    | "2.7KOHM,5%,1/8W,AA,TP,1.8X3.2MM" |         |
| R236     | 2001-000290 | R-CARBON    | "10KOHM,5%,1/8W,AA,TP,1.8X3.2MM"  |         |
| R301     | 2001-000869 | R-CARBON    | "56OHM,5%,1/8W,AA,TP,1.8X3.2MM"   |         |
| R302     | 2004-000580 | R-METAL     | "22Kohm,1%,1/4W,AA,TP,2.4x6.4mm"  |         |
| R303     | 2001-000890 | R-CARBON    | "6.8KOHM,5%,1/8W,AA,TP,1.8X3.2MM" |         |
| R304     | 2001-000890 | R-CARBON    | "6.8KOHM,5%,1/8W,AA,TP,1.8X3.2MM" |         |
| R306     | 2004-001022 | R-METAL     | "5.6Kohm,1%,1/4W,AA,TP,2.4x6.4m"  |         |
| R307     | 2001-001048 | R-CARBON(S) | "1.2OHM,5%,1/2W,AA,TP,2.4X6.4MM"  |         |
| R308     | 2001-001088 | R-CARBON(S) | "1KOHM,5%,1/2W,AA,TP,2.4X6.4MM"   |         |
| R309     | 2004-004014 | R-METAL     | "2.4ohm,1%,1/4W,AA,TP,2.4x6.4mm"  |         |
| R310     | 2004-001136 | R-METAL     | "6.8Kohm,1%,1/4W,AA,TP,2.4x6.4m"  |         |
| R311     | 2001-000890 | R-CARBON    | "6.8KOHM,5%,1/8W,AA,TP,1.8X3.2MM" |         |
| R312     | 2001-000812 | R-CARBON    | "5.6KOHM,5%,1/8W,AA,TP,1.8X3.2MM" |         |
| R315     | 2004-004014 | R-METAL     | "2.4ohm,1%,1/4W,AA,TP,2.4x6.4mm"  |         |
| R316     | 2001-000281 | R-CARBON    | "100OHM,5%,1/8W,AA,TP,1.8X3.2MM"  |         |
| R317     | 2001-000561 | R-CARBON    | "27KOHM,5%,1/4W,AA,TP,2.4X6.4MM"  |         |
| R318     | 2001-000766 | R-CARBON    | "43KOHM,5%,1/8W,AA,TP,1.8X3.2MM"  |         |
| R319     | 2001-000947 | R-CARBON    | "7.5KOHM,5%,1/8W,AA,TP,1.8X3.2MM" |         |
| R320     | 2001-000331 | R-CARBON    | "12KOHM,5%,1/8W,AA,TP,1.8X3.2MM"  |         |
| R321     | 2001-000591 | R-CARBON    | "3.3KOHM,5%,1/8W,AA,TP,1.8X3.2MM" |         |

| Loc. No. | Code No.    | Description      | Specification                     | Remarks |
|----------|-------------|------------------|-----------------------------------|---------|
| R322     | 2001-000890 | R-CARBON         | "6.8KOHM,5%,1/8W,AA,TP,1.8X3.2MM" |         |
| R323     | 2001-000022 | R-CARBON(S)      | "330HM,5%,1/2W,AA,TP,2.4X6.4MM"   |         |
| R324     | 2001-000660 | R-CARBON         | "33KOHM,5%,1/8W,AA,TP,1.8X3.2MM"  |         |
| R325     | 2003-000805 | R-METAL OXIDE(S) | "82ohm,5%,1W,AA,TP,3.3x9mm"       |         |
| R326     | 2003-000805 | R-METAL OXIDE(S) | "82ohm,5%,1W,AA,TP,3.3x9mm"       |         |
| R401     | 2004-000907 | R-METAL          | "4.7Mohm,5%,1/4W,AA,TP,2.4x6.4m"  |         |
| R402     | 2001-000869 | R-CARBON         | "56OHM,5%,1/8W,AA,TP,1.8X3.2MM"   |         |
| R403     | 2004-001226 | R-METAL          | "750ohm,1%,1/4W,AA,TP,2.4x6.4mm"  |         |
| R404     | 2004-000498 | R-METAL          | "2.7Kohm,1%,1/4W,AA,TP,2.4x6.4m"  |         |
| R405     | 2001-000591 | R-CARBON         | "3.3KOHM,5%,1/8W,AA,TP,1.8X3.2MM" |         |
| R406     | 2001-000522 | R-CARBON         | "22KOHM,5%,1/8W,AA,TP,1.8X3.2MM"  |         |
| R407     | 2001-000109 | R-CARBON(S)      | "470OHM,5%,1/2W,AA,TP,2.4X6.4MM"  |         |
| R408     | 2001-000429 | R-CARBON         | "1KOHM,5%,1/8W,AA,TP,1.8X3.2MM"   |         |
| R409     | 2001-000812 | R-CARBON         | "5.6KOHM,5%,1/8W,AA,TP,1.8X3.2MM" |         |
| R410     | 2003-000650 | R-METAL OXIDE(S) | "330ohm,5%,2W,AA,TP,4x12mm"       |         |
| R411     | 2001-001096 | R-CARBON(S)      | "2.2OHM,5%,1/2W,AA,TP,2.4X6.4MM"  |         |
| R412     | 2001-000290 | R-CARBON         | "10KOHM,5%,1/8W,AA,TP,1.8X3.2MM"  |         |
| R413     | 2001-001038 | R-CARBON(S)      | "0.56OHM,5%,1/2W,AA,TP,2.4X6.4MM" |         |
| R414     | 2001-001038 | R-CARBON(S)      | "0.56OHM,5%,1/2W,AA,TP,2.4X6.4MM" |         |
| R415     | 2003-000429 | R-METAL OXIDE(S) | "1.5Kohm,5%,2W,AA,TP,4x12mm"      |         |
| R416     | 2001-000107 | R-CARBON(S)      | "150KOHM,5%,1/2W,AA,TP,2.4X6.4MM" |         |
| R418     | 2001-000221 | R-CARBON         | "1.2KOHM,5%,1/8W,AA,TP,1.8X3.2MM" |         |
| R419     | 2001-000397 | R-CARBON         | "180KOHM,5%,1/8W,AA,TP,1.8X3.2MM" |         |
| R420     | 2001-000395 | R-CARBON         | "180KOHM,5%,1/4W,AA,TP,2.4X6.4MM" |         |
| R421     | BH39-40305U | CBF HARNESS      | "52MM,AWG22(0.6PI),-,-,AWG22(0."  |         |
| R422     | 2001-001006 | R-CARBON         | "82OHM,5%,1/8W,AA,TP,1.8X3.2MM"   |         |
| R423     | 2001-000258 | R-CARBON         | "1.8KOHM,5%,1/8W,AA,TP,1.8X3.2MM" |         |
| R424     | 2004-000284 | R-METAL          | "12Kohm,1%,1/4W,AA,TP,2.4x6.4mm"  |         |
| R425     | 2001-000044 | R-CARBON         | "1.2KOHM,5%,1/4W,AA,TP,2.4X6.4MM" |         |
| R426     | 2001-000110 | R-CARBON         | "100HM,5%,1/4W,AA,TP,2.4X6.4MM"   |         |
| R427     | 2001-000429 | R-CARBON         | "1KOHM,5%,1/8W,AA,TP,1.8X3.2MM"   |         |
| R428     | 2003-000653 | R-METAL OXIDE(S) | "330ohm,5%,3W,AA,TP,6x16mm"       |         |
| R429     | 2001-000052 | R-CARBON(S)      | "3.3KOHM,5%,1/2W,AA,TP,2.4X6.4MM" |         |
| R430     | 2001-001078 | R-CARBON(S)      | "15KOHM,5%,1/2W,AA,TP,2.4X6.4MM"  |         |
| R431     | 2003-000407 | R-METAL OXIDE(S) | "0.6ohm,5%,2W,AA,TP,4x12mm"       |         |
| R432     | 2001-000020 | R-CARBON(S)      | "22OHM,5%,1/2W,AA,TP,2.4X6.4MM"   |         |
| R434     | 2001-000449 | R-CARBON         | "2.2KOHM,5%,1/8W,AA,TP,1.8X3.2MM" |         |
| R435     | 2001-000786 | R-CARBON         | "47KOHM,5%,1/8W,AA,TP,1.8X3.2MM"  |         |
| R436     | 2001-000449 | R-CARBON         | "2.2KOHM,5%,1/8W,AA,TP,1.8X3.2MM" |         |
| R437     | 2001-000786 | R-CARBON         | "47KOHM,5%,1/8W,AA,TP,1.8X3.2MM"  |         |
| R438     | 2001-000449 | R-CARBON         | "2.2KOHM,5%,1/8W,AA,TP,1.8X3.2MM" |         |
| R439     | 2001-000786 | R-CARBON         | "47KOHM,5%,1/8W,AA,TP,1.8X3.2MM"  |         |
| R440     | 2001-000947 | R-CARBON         | "7.5KOHM,5%,1/8W,AA,TP,1.8X3.2MM" |         |
| R441     | 2001-000411 | R-CARBON         | "18KOHM,5%,1/8W,AA,TP,1.8X3.2MM"  |         |
| R443     | 2003-000502 | R-METAL OXIDE(S) | "150ohm,5%,2W,AA,TP,4x12mm"       |         |
| R444     | 2003-000767 | R-METAL OXIDE(S) | "680ohm,5%,2W,AA,TP,4x12mm"       |         |
| R445     | 2001-000019 | R-CARBON(S)      | "100HM,5%,1/2W,AA,TP,2.4X6.4MM"   |         |



| Loc. No. | Code No.    | Description      | Specification                      | Remarks |
|----------|-------------|------------------|------------------------------------|---------|
| R446     | 2001-000117 | R-CARBON(S)      | "680HM,5%,1/2W,AA,TP,2.4X6.4MM"    |         |
| R447     | 2003-000777 | R-METAL OXIDE(S) | "68ohm,5%,2W,AA,TP,4x12mm"         |         |
| R448     | 2003-000777 | R-METAL OXIDE(S) | "68ohm,5%,2W,AA,TP,4x12mm"         |         |
| R449     | 2001-000211 | R-CARBON         | "10HM,5%,1/4W,AA,TP,2.4X6.4MM"     |         |
| R450     | 2001-000563 | R-CARBON         | "27KOHM,5%,1/8W,AA,TP,1.8X3.2MM"   |         |
| R451     | 2001-000290 | R-CARBON         | "10KOHM,5%,1/8W,AA,TP,1.8X3.2MM"   |         |
| R452     | 2001-000290 | R-CARBON         | "10KOHM,5%,1/8W,AA,TP,1.8X3.2MM"   |         |
| R453     | 2001-000290 | R-CARBON         | "10KOHM,5%,1/8W,AA,TP,1.8X3.2MM"   |         |
| R454     | 2003-000650 | R-METAL OXIDE(S) | "330ohm,5%,2W,AA,TP,4x12mm"        |         |
| R500     | 2001-000435 | R-CARBON         | "1MOHM,5%,1/8W,AA,TP,1.8X3.2MM"    |         |
| R501     | 2001-000472 | R-CARBON         | "2.7KOHM,5%,1/8W,AA,TP,1.8X3.2MM"  |         |
| R502     | 2004-000979 | R-METAL          | "47Kohm,1%,1/4W,AA,TP,2.4x6.4mm"   | ⚠       |
| R503     | 2001-000449 | R-CARBON         | "2.2KOHM,5%,1/8W,AA,TP,1.8X3.2MM"  |         |
| R504     | 2001-000008 | R-CARBON         | "15KOHM,5%,1/8W,AA,TP,1.8X3.2MM"   | ⚠       |
| R505     | 2001-000241 | R-CARBON         | "1.5KOHM,5%,1/8W,AA,TP,1.8X3.2MM"  | ⚠       |
| R506     | 2004-000657 | R-METAL          | "27Kohm,1%,1/4W,AA,TP,2.4x6.4mm"   | ⚠       |
| R507     | 2004-000216 | R-METAL          | "10Kohm,1%,1/4W,AA,TP,2.4x6.4mm"   | ⚠       |
| R508     | 2002-000121 | R-COMPOSITION    | "1Mohm,10%,1/2W,AA,TP,3.5x9.5mm"   |         |
| R509     | 2002-000121 | R-COMPOSITION    | "1Mohm,10%,1/2W,AA,TP,3.5x9.5mm"   |         |
| R510     | 2001-000837 | R-CARBON         | "51KOHM,5%,1/8W,AA,TP,1.8X3.2MM"   |         |
| R511     | 2001-000478 | R-CARBON         | "2.70HM,5%,1/4W,AA,TP,2.4X6.4MM"   |         |
| R512     | 2001-000786 | R-CARBON         | "47KOHM,5%,1/8W,AA,TP,1.8X3.2MM"   | ⚠       |
| R513     | 2001-001106 | R-CARBON(S)      | "220KOHM,5%,1/2W,AA,TP,2.4X6.4MM"  |         |
| R514     | 2001-000837 | R-CARBON         | "51KOHM,5%,1/8W,AA,TP,1.8X3.2MM"   |         |
| R515     | 2001-000546 | R-CARBON         | "270KOHM,5%,1/4W,AA,TP,2.4X6.4MM"  |         |
| R516     | BH39-40305U | CBF HARNESS      | "52MM,AWG22(0.6PI),-, -,AWG22(0."" |         |
| R517     | 2001-000987 | R-CARBON         | "820KOHM,5%,1/4W,AA,TP,2.4X6.4MM"  |         |
| R518     | 2001-001031 | R-CARBON         | "91KOHM,5%,1/8W,AA,TP,1.8X3.2MM"   |         |
| R519     | 2001-000356 | R-CARBON         | "150KOHM,5%,1/8W,AA,TP,1.8X3.2MM"  |         |
| R520     | 2001-000241 | R-CARBON         | "1.5KOHM,5%,1/8W,AA,TP,1.8X3.2MM"  |         |
| R521     | BH39-40305U | CBF HARNESS      | "52MM,AWG22(0.6PI),-, -,AWG22(0."" |         |
| R522     | 2002-000121 | R-COMPOSITION    | "1Mohm,10%,1/2W,AA,TP,3.5x9.5mm"   |         |
| R524     | 2001-000660 | R-CARBON         | "33KOHM,5%,1/8W,AA,TP,1.8X3.2MM"   |         |
| R525     | 2001-000273 | R-CARBON         | "100KOHM,5%,1/8W,AA,TP,1.8X3.2MM"  |         |
| R526     | 2001-000908 | R-CARBON         | "62KOHM,5%,1/8W,AA,TP,1.8X3.2MM"   |         |
| R528     | 2001-000262 | R-CARBON         | "1.8MOHM,5%,1/8W,AA,TP,1.8X3.2MM"  |         |
| R529     | 2001-000429 | R-CARBON         | "1KOHM,5%,1/8W,AA,TP,1.8X3.2MM"    |         |
| R551     | 2001-000530 | R-CARBON         | "240KOHM,5%,1/4W,AA,TP,2.4X6.4MM"  |         |
| R552     | 2001-000537 | R-CARBON         | "24KOHM,5%,1/4W,AA,TP,2.4X6.4MM"   |         |
| R553     | 2001-001129 | R-CARBON(S)      | "330KOHM,5%,1/2W,AA,TP,2.4X6.4MM"  |         |
| R554     | 2001-001110 | R-CARBON(S)      | "240KOHM,5%,1/2W,AA,TP,2.4X6.4MM"  |         |
| R555     | 2001-000042 | R-CARBON         | "1KOHM,5%,1/4W,AA,TP,2.4X6.4MM"    |         |
| R556     | 2001-000890 | R-CARBON         | "6.8KOHM,5%,1/8W,AA,TP,1.8X3.2MM"  |         |
| R600     | 2001-001129 | R-CARBON(S)      | "330KOHM,5%,1/2W,AA,TP,2.4X6.4MM"  | ⚠       |
| R601     | 2001-001129 | R-CARBON(S)      | "330KOHM,5%,1/2W,AA,TP,2.4X6.4MM"  | ⚠       |
| R602     | 2001-000023 | R-CARBON         | "470HM,5%,1/4W,AA,TP,2.4X6.4MM"    |         |
| R603     | 2001-000290 | R-CARBON         | "10KOHM,5%,1/8W,AA,TP,1.8X3.2MM"   |         |

| Loc. No. | Code No.    | Description      | Specification  | Remarks |
|----------|-------------|------------------|--|---------|
| R604     | 2001-000857 | R-CARBON         | "560OHM,5%,1/8W,AA,TP,1.8X3.2MM"                                     |         |
| R605     | 2001-000734 | R-CARBON         | "4.7KOHM,5%,1/8W,AA,TP,1.8X3.2MM"                                    |         |
| R606     | 2003-000225 | R-METAL OXIDE    | "22Kohm,5%,1W,AA,TP,4.3x12mm"  |         |
| R607     | 2003-000225 | R-METAL OXIDE    | "22Kohm,5%,1W,AA,TP,4.3x12mm"  |         |
| R608     | 2001-000281 | R-CARBON         | "100OHM,5%,1/8W,AA,TP,1.8X3.2MM"                                     |         |
| R609     | 2002-001056 | R-COMPOSITION    | "180Kohm,2%,1/4W,AA,TP,2.5x6.5mm"                                    |         |
| R610     | 2002-001056 | R-COMPOSITION    | "180Kohm,2%,1/4W,AA,TP,2.5x6.5mm"                                    |         |
| R611     | 2001-001079 | R-CARBON(S)      | "150HM,5%,1/2W,AA,TP,2.4X6.4MM"                                      |         |
| R612     | 2003-000738 | R-METAL OXIDE(S) | "56Kohm,5%,2W,AA,TP,4x12mm"  |         |
| R613     | 2001-000290 | R-CARBON         | "10KOHM,5%,1/8W,AA,TP,1.8X3.2MM"                                     |         |
| R614     | 2001-001107 | R-CARBON(S)      | "220ohm,5%,1/2W,AA,TP,2.4x6.4mm"                                     |         |
| R615     | 2001-001088 | R-CARBON(S)      | "1KOHM,5%,1/2W,AA,TP,2.4X6.4MM"                                      |         |
| R617     | 2001-001037 | R-CARBON(S)      | "0.390HM,5%,1/2W,AA,TP,2.4X6.4MM"                                    |         |
| R618     | 2001-000429 | R-CARBON         | "1KOHM,5%,1/8W,AA,TP,1.8X3.2MM"                                      |         |
| R619     | 2003-000471 | R-METAL OXIDE(S) | "10ohm,5%,2W,AA,TP,4x12mm"   |         |
| R620     | 2001-000354 | R-CARBON         | "150KOHM,5%,1/4W,AA,TP,2.4X6.4MM"                                    |         |
| R621     | 2001-000989 | R-CARBON         | "820KOHM,5%,1/8W,AA,TP,1.8X3.2MM"                                    |         |
| R622     | 2001-000211 | R-CARBON         | "1OHM,5%,1/4W,AA,TP,2.4X6.4MM"                                       |         |
| R625     | 2001-000786 | R-CARBON         | "47KOHM,5%,1/8W,AA,TP,1.8X3.2MM"                                     |         |
| R630     | 2001-000786 | R-CARBON         | "47KOHM,5%,1/8W,AA,TP,1.8X3.2MM"                                     |         |
| R631     | 2001-000429 | R-CARBON         | "1KOHM,5%,1/8W,AA,TP,1.8X3.2MM"                                      |         |
| R632     | 2001-000290 | R-CARBON         | "10KOHM,5%,1/8W,AA,TP,1.8X3.2MM"                                     |         |
| R633     | 2001-000211 | R-CARBON         | "1OHM,5%,1/4W,AA,TP,2.4X6.4MM"                                       |         |
| SK501    | 4715-000001 | SURGE ABSORBER   | "1KV,+50-10%,--,"  |         |
| SW201    | 3404-000244 | SWITCH-TACT      | "15V,20mA,90-170gf,7.5x7mm,SPST"                                     |         |
| SW202    | 3404-000244 | SWITCH-TACT      | "15V,20mA,90-170gf,7.5x7mm,SPST"                                     |         |
| SW203    | 3404-000244 | SWITCH-TACT      | "15V,20mA,90-170gf,7.5x7mm,SPST"                                     |         |
| SW204    | 3404-000244 | SWITCH-TACT      | "15V,20mA,90-170gf,7.5x7mm,SPST"                                     |         |
| TP501    | 6042-000002 | EYELET           | "ID1.5,OD2,L3.1,SN,BSS3-E/EH"  |         |
| X201     | 2801-000005 | CRYSTAL-UNIT     | "8MHz,50ppm,28-AAM,S,35ohm,TP"                                       |         |
| ZD201    | 0403-000355 | DIODE-ZENER      | "UZ5.1BSB,5.1V,4.97-5.18V,500mW"                                     |         |
| ZD202    | 0403-000355 | DIODE-ZENER      | "UZ5.1BSB,5.1V,4.97-5.18V,500mW"                                     |         |
| ZD203    | 0403-000355 | DIODE-ZENER      | "UZ5.1BSB,5.1V,4.97-5.18V,500mW"                                     |         |
| ZD204    | 0403-000355 | DIODE-ZENER      | "UZ5.1BSB,5.1V,4.97-5.18V,500mW"                                     |         |
| ZD205    | 0403-000361 | DIODE-ZENER      | "UZ6.2BSB,6.2V,5.99-6.24V,500mW"                                     |         |
| ZD502    | 0403-001068 | DIODE-ZENER      | "UZ4.7BSA,4.7V,4.47-4.65V,500mW"                                     |         |
| ZD601    | 0403-000361 | DIODE-ZENER      | "UZ6.2BSB,6.2V,5.99-6.24V,500mW"                                     |         |
| ZD603    | 0403-001068 | DIODE-ZENER      | "UZ4.7BSA,4.7V,4.47-4.65V,500mW"                                     |         |
| HS501    | BH99-00001B | "ASSY,HEAT/SINK" | "H/S FBT,SPRING,KA5802,DTV56F,KSC2058,OIL SILICON,-,-"               |         |
| CIS      | 0402-001255 | DIODE-RECTIFIER  | "DTV56F,1.5KV,10A,TO-220AC,BK"                                       |         |
| CIS      | 0502-000465 | TR-POWER         | "KTD2058-Y,NPN,25W,TO-220IS,ST,"                                     |         |
| CIS      | 0502-001129 | TR-POWER         | "KSC5802,NPN,70W,TO-3PF,ST,5-"                                       |         |
| CIS      | BH61-00004A | SPRING-TR        | "CDA,CDB,SUS304,T0.5,-,-,-,"   |         |
| CIS      | BH61-70003A | SPRING           | "CVT4857,STS304-W1/2H,T0.5,W3.8"                                     |         |
| CIS      | BH62-00002A | HEAT/SINK-FBT    | "-,T1.0,-,A1050S,DA/DB"  |         |
| HS301    | BH99-00002A | "ASSY,HEAT/SINK" | "H/S V.IC,SCREW+NUT,KA2142,-,-,OIL SILICON,-,-"                      |         |
| CIS      | 1204-001508 | IC-VERTICAL DEF. | "KA2142,SIP,10P,-,PLASTIC,35V,15W,-,20TO+70C,ST,VERTICAL DEFLECTION" |         |



2 Electrical Parts List

| Loc. No. | Code No.    | Description      | Specification                              | Remarks |
|----------|-------------|------------------|--|---------|
| CIS      | 6006-001008 | SCREW-ASS'Y MACH | "WSP,BH,+,M3,L10,ZPC(YEL),SWRCH"           |         |
| CIS      | 6021-000118 | NUT-HEXAGON      | "1C,M3,ZPC(YEL),SM20C"                     |         |
| CIS      | BH62-00003A | HEAT/SINK-V.IC   | "-,T1,-,A1050S,DA/DB"                      |         |
| HS601    | BH99-00003A | "ASSY,HEAT/SINK" | "H/S POWER,SPRING,DP104,-,-,RUBBER,-,-"    |         |
| CIS      | BH13-00004A | IC-HYBRID        | "-,DP104C,TO-220-5L,5P,POWER SWITCH,-,-"   |         |
| CIS      | BH61-00004A | SPRING-TR        | "CDA,CDB,SUS304,T0.5,-,-,-,-"              |         |
| CIS      | BH62-00004A | HEAT/SINK-POWER  | "-,T1,-,A1050S,DA/DB"                      |         |
| CIS      | BH62-20001B | RUBBER           | "CSQ4357,W25*L20*T0.45,-,-,-,-"            |         |
| HS401    | BH99-00006A | "ASSY,HEAT/SINK" | "H/S,SCREW+NUT,IRF630,-,-,OIL SILICON,-,-" |         |
| CIS      | 6006-001008 | SCREW-ASS'Y MACH | "WSP,BH,+,M3,L10,ZPC(YEL),SWRCH"           |         |
| CIS      | 6021-000118 | NUT-HEXAGON      | "1C,M3,ZPC(YEL),SM20C"                     |         |
| CIS      | BH62-30024A | HEAT/SINK-TR     | "SPC,T1,SN,CFX1577L"                       |         |
| HS402    | BH99-00015A | ASSY HEAT/SINK   | "HS TR,SPRING,IRF630(SGS),-,-,OIL SILICON" |         |
| CIS      | BH61-00004A | SPRING-TR        | "CDA,CDB,SUS304,T0.5,-,-,-,-"              |         |
| CIS      | BH62-00024A | HEAT SINK—TR     | "SPC-1,T1.0,-,DT,IBM TANGO"                |         |

## 2-2 Video PCB Parts

| Loc. No.  | Code No.    | Description           | Specification  | Remarks   |
|-----------|-------------|-----------------------|--|---|
| CIS       | BH71-00006A | SHIELD-VIDEO/CAP      | "CDA4507,SPT,E,T0.2,-,-"   |   |
| CIS       | BH75-00192H | UNIT/SHIELD-VIDEO     | "DEL,-,SPT,E,-,-,14""",15""",17""",-,"   |   |
| CIS       | BH61-00002A | SPRING-VIDEO          | "CDB7907,STS H14 ,T1.0,-,-,-,NORMAL CDT"                                       |   |
| CIS       | BH71-00007A | SHIELD-VIDEO          | "CDA4507,SPT,E,T0.2,-,-"   |   |
| CIS       | BH72-00024A | HOLDER-VIDEO          | "CDA4507,ABS+PC,5V,IV16,-,NORMAL CRT"  |   |
| CIS       | BH73-00014A | HOLDER-RUBBER(NORMAL) | "DEL,SILICON V2,GRAY,-,-,-,NORMAL"   |   |
| CN101     | 3711-004228 | CONNECTOR-HEADER      | "BOX,6P,1R,2MM,ANGLE,SN"   |   |
| CN102     | BH39-00015A | CBF-HARNESS           | "13P/14P,200MM,WHT/BLK/RED/BLU,UL1007,AWG26,SMH200-13/YBNH200-14"              |   |
| IC101     | 1201-001409 | IC-VIDEO AMP          | "S1D2506A01,DIP,28P,600MIL,SINGLE,-,PLASTIC,13.2V,2.0,-20to+70CC,-,-,-,-,ST"   |  |
| IC104     | 1204-001529 | IC-OSD PROCESSOR      | "S5D2501E09,DIP,24P,300MIL,PLASTIC,6.5V,1200mV,0to+70C,ST,2""±(ENGLISH/CHINA)" |   |
| LJP1      | BH39-40306D | CBF-HARNESS           | "-,80MM,BLK,1015,AWG22,-,-,-,-,-"  |   |
| S/VID     | 6502-000001 | CABLE CLAMP           | "DAWH-5NB,D15,L35,NTR,NYLON66"   |   |
| S/VID+H/S | 6003-000010 | SCREW-TAPTITE         | "BWH,+ ,B,M3,L10,ZPC(YEL),SWRCH1"  |   |
| SK01      | 3704-001116 | SOCKET-CRT            | "11P,22.5PI,26.5PI,NI,-"   |   |
| SK102     | 4715-000001 | SURGE ABSORBER        | "1KV,+50-10%,-,-,-"  |   |
| V_BOTTOM  | BH39-40361A | CBF-HARNESS           | "-,40MM,BLK,UL 1015,AWG22,-"   |   |
| BD101     | 3301-000011 | CORE-FERRITE BEAD     | "AA,3.5x1.0x5.7mm,1500,2375G"  |   |
| BD102     | 3301-000011 | CORE-FERRITE BEAD     | "AA,3.5x1.0x5.7mm,1500,2375G"  |   |
| BD103     | 3301-000011 | CORE-FERRITE BEAD     | "AA,3.5x1.0x5.7mm,1500,2375G"  |   |
| C101      | 2202-002009 | "C-CERAMIC,MLC-AXIAL" | "100nF,+80-20%,50V,Y5V,TP,2.3X3"   |   |
| C102      | 2401-001334 | C-AL                  | "470nF,20%,50V,GP,TP,5x11,2.5"   |   |
| C103      | 2401-000037 | C-AL                  | "470uF,20%,16V,GP,TP,8x11.5,5"   |   |
| C104      | 2202-002008 | "C-CERAMIC,MLC-AXIAL" | "10nF,+80-20%,50V,Y5V,TP,2.3X3."   |   |
| C105      | 2202-002009 | "C-CERAMIC,MLC-AXIAL" | "100nF,+80-20%,50V,Y5V,TP,2.3X3"   |   |
| C106      | 2202-002009 | "C-CERAMIC,MLC-AXIAL" | "100nF,+80-20%,50V,Y5V,TP,2.3X3"   |   |
| C107      | 2401-000010 | C-AL                  | "220uF,20%,16V,GP,-,6.3x11mm,2."   |   |
| C108      | 2401-001459 | C-AL                  | "47uF,20%,100V,GP,TP,10x16.5,5"  |   |
| C110      | 2401-000037 | C-AL                  | "470uF,20%,16V,GP,TP,8x11.5,5"   |   |
| C111      | 2401-000031 | C-AL                  | "47uF,20%,16V,GP,TP,5x11,5"  |   |
| C112      | 2401-000050 | C-AL                  | "10uF,20%,16V,GP,TP,5x11,2.5"  |   |
| C113      | 2202-002009 | "C-CERAMIC,MLC-AXIAL" | "100nF,+80-20%,50V,Y5V,TP,2.3X3"   |   |
| C114      | 2301-000014 | "C-FILM,PEF"          | "6.8nF,5%,100V,TP,5.8x12.5mm,5m"   |   |
| C116      | 2301-000188 | "C-FILM,PEF"          | "1nF,5%,100V,TP,10.5x12.5x6.5,5"   |   |
| C117      | 2301-000106 | "C-FILM,PEF"          | "1.5nF,0.05,100V,TP,10.5*12.5*6"   |   |
| C118      | 2201-000471 | "C-CERAMIC,DISC"      | "0.33nF,10%,50V,Y5P,TP,4x3.5,5"  |   |
| C119      | 2201-000291 | "C-CERAMIC,DISC"      | "1nF,10%,500V,Y5P,TP,7.5x3.5,5"  |   |
| C120      | 2201-000285 | "C-CERAMIC,DISC"      | "1nF,10%,1kV,Y5P,TP,8x5,5"   |   |
| C121      | 2301-000010 | "C-FILM,PEF"          | "100nF,5%,100V,TP,11.5x12.5mm,5"   |   |
| C122      | 2201-000117 | "C-CERAMIC,DISC"      | "1.8nF,10%,500V,Y5P,TP,8.5x3,5"  |   |
| C123      | 2301-000148 | "C-FILM,PEF"          | "10nF,5%,100V,TP,7x3.2x7mm,5mm"  |   |
| C124      | 2301-000148 | "C-FILM,PEF"          | "10nF,5%,100V,TP,7x3.2x7mm,5mm"  |   |
| C125      | 2401-000010 | C-AL                  | "220uF,20%,16V,GP,-,6.3x11mm,2."   |   |
| CB01      | 2202-002009 | "C-CERAMIC,MLC-AXIAL" | "100nF,+80-20%,50V,Y5V,TP,2.3X3"   |   |
| CB02      | 2202-002009 | "C-CERAMIC,MLC-AXIAL" | "100nF,+80-20%,50V,Y5V,TP,2.3X3"   |   |
| CB04      | 2401-000055 | C-AL                  | "1uF,20%,160V,WT,TP,3x11,5mm"  |   |
| CB05      | 2301-000010 | "C-FILM,PEF"          | "100nF,5%,100V,TP,11.5x12.5mm,5"   |   |
| CB06      | 2202-002009 | "C-CERAMIC,MLC-AXIAL" | "100nF,+80-20%,50V,Y5V,TP,2.3X3"   |   |

| Loc. No. | Code No.    | Description           | Specification                    | Remarks |
|----------|-------------|-----------------------|----------------------------------|---------|
| CG01     | 2202-002009 | "C-CERAMIC,MLC-AXIAL" | "100nF,+80-20%,50V,Y5V,TP,2.3X3" |         |
| CG02     | 2202-002009 | "C-CERAMIC,MLC-AXIAL" | "100nF,+80-20%,50V,Y5V,TP,2.3X3" |         |
| CG03     | 2201-000483 | "C-CERAMIC,DISC"      | "0.033nF,5%,50V,NP0,TP,5x3.5,5"  |         |
| CG04     | 2401-000055 | C-AL                  | "1uF,20%,160V,WT,TP,3x11,5mm"    |         |
| CG05     | 2301-000010 | "C-FILM,PEF"          | "100nF,5%,100V,TP,11.5x12.5mm,5" |         |
| CG06     | 2202-002009 | "C-CERAMIC,MLC-AXIAL" | "100nF,+80-20%,50V,Y5V,TP,2.3X3" |         |
| CR01     | 2202-002009 | "C-CERAMIC,MLC-AXIAL" | "100nF,+80-20%,50V,Y5V,TP,2.3X3" |         |
| CR02     | 2202-002009 | "C-CERAMIC,MLC-AXIAL" | "100nF,+80-20%,50V,Y5V,TP,2.3X3" |         |
| CR04     | 2401-000055 | C-AL                  | "1uF,20%,160V,WT,TP,3x11,5mm"    |         |
| CR05     | 2301-000010 | "C-FILM,PEF"          | "100nF,5%,100V,TP,11.5x12.5mm,5" |         |
| CR06     | 2202-002009 | "C-CERAMIC,MLC-AXIAL" | "100nF,+80-20%,50V,Y5V,TP,2.3X3" |         |
| D101     | 0401-000005 | DIODE-SWITCHING       | "1N4148,100V,200MA,DO-35,TP"     |         |
| D102     | 0401-000005 | DIODE-SWITCHING       | "1N4148,100V,200MA,DO-35,TP"     |         |
| D103     | 0401-000005 | DIODE-SWITCHING       | "1N4148,100V,200MA,DO-35,TP"     |         |
| DB01     | 0401-000005 | DIODE-SWITCHING       | "1N4148,100V,200MA,DO-35,TP"     |         |
| DB02     | 0401-000005 | DIODE-SWITCHING       | "1N4148,100V,200MA,DO-35,TP"     |         |
| DB03     | 0401-000004 | DIODE-SWITCHING       | "1SS244,250V,200mA,DO-34,TP"     |         |
| DB04     | 0401-000004 | DIODE-SWITCHING       | "1SS244,250V,200mA,DO-34,TP"     |         |
| DB05     | 0401-000005 | DIODE-SWITCHING       | "1N4148,100V,200MA,DO-35,TP"     |         |
| DB06     | 0401-000005 | DIODE-SWITCHING       | "1N4148,100V,200MA,DO-35,TP"     |         |
| DG01     | 0401-000005 | DIODE-SWITCHING       | "1N4148,100V,200MA,DO-35,TP"     |         |
| DG02     | 0401-000005 | DIODE-SWITCHING       | "1N4148,100V,200MA,DO-35,TP"     |         |
| DG03     | 0401-000004 | DIODE-SWITCHING       | "1SS244,250V,200mA,DO-34,TP"     |         |
| DG04     | 0401-000004 | DIODE-SWITCHING       | "1SS244,250V,200mA,DO-34,TP"     |         |
| DG05     | 0401-000005 | DIODE-SWITCHING       | "1N4148,100V,200MA,DO-35,TP"     |         |
| DG06     | 0401-000005 | DIODE-SWITCHING       | "1N4148,100V,200MA,DO-35,TP"     |         |
| DR01     | 0401-000005 | DIODE-SWITCHING       | "1N4148,100V,200MA,DO-35,TP"     |         |
| DR02     | 0401-000005 | DIODE-SWITCHING       | "1N4148,100V,200MA,DO-35,TP"     |         |
| DR03     | 0401-000004 | DIODE-SWITCHING       | "1SS244,250V,200mA,DO-34,TP"     |         |
| DR04     | 0401-000004 | DIODE-SWITCHING       | "1SS244,250V,200mA,DO-34,TP"     |         |
| DR05     | 0401-000005 | DIODE-SWITCHING       | "1N4148,100V,200MA,DO-35,TP"     |         |
| DR06     | 0401-000005 | DIODE-SWITCHING       | "1N4148,100V,200MA,DO-35,TP"     |         |
| EY1      | 6042-000002 | EYELET                | "ID1.5,OD2,L3.1,SN,BSS3-E/EH"    |         |
| EY2      | 6042-000001 | EYELET                | "ID2.2,OD2.7,L3.1,SN,BSS3-E/EH"  |         |
| EY3      | 6042-000001 | EYELET                | "ID2.2,OD2.7,L3.1,SN,BSS3-E/EH"  |         |
| G2       | BH71-40300A | PIN-HINGE             | "-.BRASS,D2.36,SN,HEAT/SINK"     |         |
| GND      | BH71-40300A | PIN-HINGE             | "-.BRASS,D2.36,SN,HEAT/SINK"     |         |
| JP101    | BH39-40305U | CBF HARNESS           | "52MM,AWG22(0.6PI),-,-,AWG22(0." |         |
| JP102    | BH39-40305U | CBF HARNESS           | "52MM,AWG22(0.6PI),-,-,AWG22(0." |         |
| JP103    | BH39-40305U | CBF HARNESS           | "52MM,AWG22(0.6PI),-,-,AWG22(0." |         |
| JP104    | BH39-40305U | CBF HARNESS           | "52MM,AWG22(0.6PI),-,-,AWG22(0." |         |
| JP105    | BH39-40305U | CBF HARNESS           | "52MM,AWG22(0.6PI),-,-,AWG22(0." |         |
| JP106    | BH39-40305U | CBF HARNESS           | "52MM,AWG22(0.6PI),-,-,AWG22(0." |         |
| JP107    | BH39-40305U | CBF HARNESS           | "52MM,AWG22(0.6PI),-,-,AWG22(0." |         |
| JP108    | BH39-40305U | CBF HARNESS           | "52MM,AWG22(0.6PI),-,-,AWG22(0." |         |
| JP109    | BH39-40305U | CBF HARNESS           | "52MM,AWG22(0.6PI),-,-,AWG22(0." |         |
| JP110    | BH39-40305U | CBF HARNESS           | "52MM,AWG22(0.6PI),-,-,AWG22(0." |         |

| Loc. No. | Code No.    | Description     | Specification                     | Remarks |
|----------|-------------|-----------------|-----------------------------------|---------|
| JP111    | BH39-40305U | CBF HARNESS     | "52MM,AWG22(0.6PI),-,-,AWG22(0."  |         |
| JP112    | BH39-40305U | CBF HARNESS     | "52MM,AWG22(0.6PI),-,-,AWG22(0."  |         |
| JP113    | BH39-40305U | CBF HARNESS     | "52MM,AWG22(0.6PI),-,-,AWG22(0."  |         |
| JP114    | BH39-40305U | CBF HARNESS     | "52MM,AWG22(0.6PI),-,-,AWG22(0."  |         |
| JP115    | BH39-40305U | CBF HARNESS     | "52MM,AWG22(0.6PI),-,-,AWG22(0."  |         |
| JP116    | BH39-40305U | CBF HARNESS     | "52MM,AWG22(0.6PI),-,-,AWG22(0."  |         |
| JP117    | BH39-40305U | CBF HARNESS     | "52MM,AWG22(0.6PI),-,-,AWG22(0."  |         |
| JP118    | BH39-40305U | CBF HARNESS     | "52MM,AWG22(0.6PI),-,-,AWG22(0."  |         |
| JP119    | BH39-40305U | CBF HARNESS     | "52MM,AWG22(0.6PI),-,-,AWG22(0."  |         |
| LB01     | 2701-000190 | INDUCTOR-AXIAL  | "470nH,10%,4x9.8mm"               |         |
| LG01     | 2701-000190 | INDUCTOR-AXIAL  | "470nH,10%,4x9.8mm"               |         |
| LR01     | 2701-000190 | INDUCTOR-AXIAL  | "470nH,10%,4x9.8mm"               |         |
| MP2.1    | BH41-00013A | PCB-DISPLAY     | "-,-FR-1,1 LAYER,1.6T,-"          |         |
| Q101     | 0501-000122 | TR-SMALL SIGNAL | "2N3904,NPN,625mW,TO-92,TP,100-"  |         |
| Q102     | 0501-000122 | TR-SMALL SIGNAL | "2N3904,NPN,625mW,TO-92,TP,100-"  |         |
| QB01     | 0501-000140 | TR-SMALL SIGNAL | "2N5551,NPN,625mW,TO-92,-,80-25"  |         |
| QB02     | 0501-000138 | TR-SMALL SIGNAL | "2N5401,PNP,625mW,TO-92,TP,60-2"  |         |
| QG01     | 0501-000140 | TR-SMALL SIGNAL | "2N5551,NPN,625mW,TO-92,-,80-25"  |         |
| QG02     | 0501-000138 | TR-SMALL SIGNAL | "2N5401,PNP,625mW,TO-92,TP,60-2"  |         |
| QR01     | 0501-000140 | TR-SMALL SIGNAL | "2N5551,NPN,625mW,TO-92,-,80-25"  |         |
| QR02     | 0501-000138 | TR-SMALL SIGNAL | "2N5401,PNP,625mW,TO-92,TP,60-2"  |         |
| R101     | 2001-000290 | R-CARBON        | "10KOHM,5%,1/8W,AA,TP,1.8X3.2MM"  |         |
| R102     | 2001-000281 | R-CARBON        | "100OHM,5%,1/8W,AA,TP,1.8X3.2MM"  |         |
| R103     | 2001-001138 | R-CARBON(S)     | "390OHM,5%,1/2W,AA,TP,2.4X6.4MM"  |         |
| R104     | 2001-001138 | R-CARBON(S)     | "390OHM,5%,1/2W,AA,TP,2.4X6.4MM"  |         |
| R105     | 2001-000290 | R-CARBON        | "10KOHM,5%,1/8W,AA,TP,1.8X3.2MM"  |         |
| R106     | 2001-000429 | R-CARBON        | "1KOHM,5%,1/8W,AA,TP,1.8X3.2MM"   |         |
| R107     | 2001-000429 | R-CARBON        | "1KOHM,5%,1/8W,AA,TP,1.8X3.2MM"   |         |
| R108     | 2001-000857 | R-CARBON        | "560OHM,5%,1/8W,AA,TP,1.8X3.2MM"  |         |
| R109     | 2001-000290 | R-CARBON        | "10KOHM,5%,1/8W,AA,TP,1.8X3.2MM"  |         |
| R110     | 2001-000812 | R-CARBON        | "5.6KOHM,5%,1/8W,AA,TP,1.8X3.2MM" |         |
| R111     | 2001-000563 | R-CARBON        | "27KOHM,5%,1/8W,AA,TP,1.8X3.2MM"  |         |
| R113     | 2001-000429 | R-CARBON        | "1KOHM,5%,1/8W,AA,TP,1.8X3.2MM"   |         |
| R114     | 2001-000780 | R-CARBON        | "470OHM,5%,1/8W,AA,TP,1.8X3.2MM"  |         |
| R115     | 2001-000577 | R-CARBON        | "2KOHM,5%,1/8W,AA,TP,1.8X3.2MM"   |         |
| R116     | 2001-000290 | R-CARBON        | "10KOHM,5%,1/8W,AA,TP,1.8X3.2MM"  |         |
| R117     | 2001-000515 | R-CARBON        | "220OHM,5%,1/8W,AA,TP,1.8X3.2MM"  |         |
| R118     | 2001-000281 | R-CARBON        | "100OHM,5%,1/8W,AA,TP,1.8X3.2MM"  |         |
| R119     | 2001-000281 | R-CARBON        | "100OHM,5%,1/8W,AA,TP,1.8X3.2MM"  |         |
| R141     | 2001-000005 | R-CARBON        | "390ohm,5%,1/8W,AA,TP,1.8x3.2mm"  |         |
| R142     | 2001-000005 | R-CARBON        | "390ohm,5%,1/8W,AA,TP,1.8x3.2mm"  |         |
| R143     | 2001-000005 | R-CARBON        | "390ohm,5%,1/8W,AA,TP,1.8x3.2mm"  |         |
| R144     | 2001-000005 | R-CARBON        | "390ohm,5%,1/8W,AA,TP,1.8x3.2mm"  |         |
| RB01     | 2001-000969 | R-CARBON        | "75OHM,5%,1/8W,AA,TP,1.8X3.2MM"   |         |
| RB02     | 2001-000969 | R-CARBON        | "75OHM,5%,1/8W,AA,TP,1.8X3.2MM"   |         |
| RB03     | 2001-000005 | R-CARBON        | "390ohm,5%,1/8W,AA,TP,1.8x3.2mm"  |         |
| RB04     | 2001-000302 | R-CARBON        | "100OHM,5%,1/8W,AA,TP,1.8X3.2MM"  |         |

| Loc. No. | Code No.    | Description      | Specification                                 | Remarks |
|----------|-------------|------------------|---|---------|
| RB08     | 2001-00027  | R-CARBON         | "100OHM,5%,1/4W,AA,TP,2.4X6.4MM"              |         |
| RB09     | 2001-000962 | R-CARBON         | "75KOHM,5%,1/4W,AA,TP,2.4X6.4MM"              |         |
| RB10     | 2001-000705 | R-CARBON         | "390HM,5%,1/2W,AA,TP,3.3X9MM"                 |         |
| RB11     | 2001-000281 | R-CARBON         | "100OHM,5%,1/8W,AA,TP,1.8X3.2MM"              |         |
| RB12     | 2001-000449 | R-CARBON         | "2.2KOHM,5%,1/8W,AA,TP,1.8X3.2MM"             |         |
| RB13     | 2001-001000 | R-CARBON         | "82KOHM,5%,1/8W,AA,TP,1.8X3.2MM"              |         |
| RG01     | 2001-000969 | R-CARBON         | "75OHM,5%,1/8W,AA,TP,1.8X3.2MM"               |         |
| RG02     | 2001-000969 | R-CARBON         | "75OHM,5%,1/8W,AA,TP,1.8X3.2MM"               |         |
| RG03     | 2001-000005 | R-CARBON         | "390ohm,5%,1/8W,AA,TP,1.8x3.2mm"              |         |
| RG04     | 2001-000302 | R-CARBON         | "100HM,5%,1/8W,AA,TP,1.8X3.2MM"               |         |
| RG05     | 2001-000004 | R-CARBON         | "200KOHM,5%,1/8W,AA,TP,1.8X3.2MM"             |         |
| RG08     | 2001-000027 | R-CARBON         | "100OHM,5%,1/4W,AA,TP,2.4X6.4MM"              |         |
| RG09     | 2001-000962 | R-CARBON         | "75KOHM,5%,1/4W,AA,TP,2.4X6.4MM"              |         |
| RG10     | 2001-000705 | R-CARBON         | "390HM,5%,1/2W,AA,TP,3.3X9MM"                 |         |
| RG11     | 2001-000281 | R-CARBON         | "100OHM,5%,1/8W,AA,TP,1.8X3.2MM"              |         |
| RG12     | 2001-000449 | R-CARBON         | "2.2KOHM,5%,1/8W,AA,TP,1.8X3.2MM"             |         |
| RG13     | 2001-001000 | R-CARBON         | "82KOHM,5%,1/8W,AA,TP,1.8X3.2MM"              |         |
| RR01     | 2001-000969 | R-CARBON         | "75OHM,5%,1/8W,AA,TP,1.8X3.2MM"               |         |
| RR02     | 2001-000969 | R-CARBON         | "75OHM,5%,1/8W,AA,TP,1.8X3.2MM"               |         |
| RR03     | 2001-000005 | R-CARBON         | "390ohm,5%,1/8W,AA,TP,1.8x3.2mm"              |         |
| RR04     | 2001-000302 | R-CARBON         | "100HM,5%,1/8W,AA,TP,1.8X3.2MM"               |         |
| RR08     | 2001-000027 | R-CARBON         | "100OHM,5%,1/4W,AA,TP,2.4X6.4MM"              |         |
| RR09     | 2001-000962 | R-CARBON         | "75KOHM,5%,1/4W,AA,TP,2.4X6.4MM"              |         |
| RR10     | 2001-000705 | R-CARBON         | "390HM,5%,1/2W,AA,TP,3.3X9MM"                 |         |
| RR11     | 2001-000281 | R-CARBON         | "100OHM,5%,1/8W,AA,TP,1.8X3.2MM"              |         |
| RR12     | 2001-000449 | R-CARBON         | "2.2KOHM,5%,1/8W,AA,TP,1.8X3.2MM"             |         |
| RR13     | 2001-001000 | R-CARBON         | "82KOHM,5%,1/8W,AA,TP,1.8X3.2MM"              |         |
| SK101    | 1405-001064 | SURGE ABSORBER   | "400V,20%,--,AXIAL"                           |         |
| SKB01    | 4715-000102 | SURGE ABSORBER   | "200V,20%,1000A,-,RADIAL"                     |         |
| SKG01    | 4715-000102 | SURGE ABSORBER   | "200V,20%,1000A,-,RADIAL"                     |         |
| SKR01    | 4715-000102 | SURGE ABSORBER   | "200V,20%,1000A,-,RADIAL"                     |         |
| HS103    | BH99-00004B | "ASSY,HEAT/SINK" | "H/S VIDEO,SCREW+NUT,LM2437,-,OIL SILICON,-," |         |
| CIS      | 6006-001008 | SCREW-ASS'Y MACH | "WSP,BH,+,M3,L10,ZPC(YEL),SWRCH"              |         |
| CIS      | 6021-000118 | NUT-HEXAGON      | "1C,M3,ZPC(YEL),SM20C"                        |         |
| CIS      | BH13-00003A | IC-HYBRID        | "-,LM2437,TO-220,9P,CRT DRIVER,0 TO 6.0V,-,"  |         |
| CIS      | BH62-00006A | HEAT SINK-VIDEO  | "-,A1050S T2.0,-,DB"                          |         |

## 2-3 Others

| Loc. No. | Code No.     | Description           | Specification                   | Remarks |
|----------|--------------|-----------------------|---------------------------------|---------|
|          | BH03-00015A  | CRT-COLOR             | 0.28,M41QAR361X114(T4/S-2),DYNA |         |
|          | BH03-10342B  | CRT-COLOR             | 0.28,M41QAR361X111(A/S2),D      |         |
|          | BH94-00048C  | ASSY,PCB              | DP17L*                          |         |
|          | BH98-00036C1 | ASSY,PCB/MAIN         | DP17L*                          |         |
|          | BH98-00037C  | ASSY,PCB/VIDEO        | DP17L*                          |         |
| S/CABLE  | BH39-00016A  | CBF-SIGNAL            | 1550MM,IVORY(IV01),2990         |         |
| MAGNET   | 3302-000006  | MAGNET-RUBBER         | AF,14G,1620-1980G,0.58-0.9      |         |
|          | BH27-00015A  | COIL DEGAUSSING-ASS'Y | 290*265*1100MM,9.6              | 17"     |
| P/CORD   | BH39-10007A  | CBF POWER/CORD        | DET,H05VV-F,250V/6A,IVY,1830MM  |         |
|          | BH39-10339E  | CBF POWER/CORD        | DET,SVT,125V 7A/10A,IVY,1830MM  |         |

## 2-4 Different Parts list (TDA9113)

|             | SDI CDT | TSB NORMAL CDT | TSB Mini Neck CDT | LG CDT | HITACHI CDT | ORION CDT |
|-------------|---------|----------------|-------------------|--------|-------------|-----------|
| H/VOLTAGE   | 26.0kV  | 26.5kV         | 26.0kV            | 26.0kV | 26.0kV      | 26.0kV    |
| G2 /VOLTAGE | 480V    | 630V           | 630V              | 480V   | 530V        | 480V      |
| CORNER-C    | 42/4D   | 3D/41          | 40/42             | 40/41  | 40/42       | 40/42     |
| V-LINER.    | 22      | 11             | 1D                | 22     | 22          | 22        |

| Loc. No.     | SDI CDT                           | TSB NORMAL CDT                    | TSB Mini Neck   |
|--------------|-----------------------------------|-----------------------------------|---|
| R516         | 2002-001063 ; R-COMP,1/2W,160k    | 2002-001056 ; R-COMP,1/4W,180k    | 2002-001056 ; R-COMP,1/4W,180k                              |
| R450         | 2001-000963 ; R-CF,1/8W,75K       | 2001-001000 ; R-CF,1/8W,82k       | 2001-000010 ; R-CF,1/8W,68Kohm                              |
| R656         | 2001-000411 ; R-CF,1/8W,18KOHM    | 2001-000411 ; R-CF,1/8W,18KOHM    | 2001-000009 ; R-CF,1/8W,20KOHM                              |
| R308         | 2001-000109 ; R-CF(S),1/2W,470OHM | 2001-001138 ; R-CF(S),1/2W,390OHM | 2001-000109 ; R-CF(S),1/2W,470OHM                           |
| R309         | 2004-005002 ; R-MF,1/2W,1.2ohm,2% | 2004-005002 ; R-MF,1/2W,1.2ohm,2% | 2004-005003 ; R-MF,1/2W,1.5ohm,2%                           |
| R315         | 2004-005002 ; R-MF,1/2W,1.2ohm,2% | 2004-005002 ; R-MF,1/2W,1.2ohm,2% | 2004-005003 ; R-MF,1/2W,1.5ohm,2%                           |
| CIS          | -                                 | -                                 | 2201-000823 ; C-CERA,50V,270pF                              |
| C419         | 2301-001305 ; C-FILM,2.2nF,1.6kV  | 2301-001305 ; C-FILM,2.2nF,1.6kV  | 2303-001022 ; C-PPF,2.0nF,2.5kV                             |
| C420         | 2301-001306 ; C-FILM,2.5nF,1.6kV  | 2301-001306 ; C-FILM,2.5nF,1.6kV  | 2303-001022 ; C-PPF,2.0nF,2.5kV                             |
| R455         | 2004-000327 ; R-MF,1/4W,150k      | 2004-000327 ; R-MF,1/4W,150k      | 2004-000964 ; R-MF,1/4W,470k                                |
| R461         | 2004-000193 ; R-MF,1/4W,100k      | 2004-000193 ; R-MF,1/4W,100k      | 2004-000560 ; R-MF,1/4W,220k                                |
| R526         | 2004-000284 ; R-MF,1/4W,12k       | 2004-000284 ; R-MF,1/4W,12k       | 2004-000344 ; R-MF,1/4W,15k                                 |
| R501         | 2001-000472 ; R-CF,1/8W,2.7k      | 2001-000472 ; R-CF,1/8W,2.7k      | 2001-000241 ; R-CF,1/8W,1.5k                                |
| R520         | 2001-000241 ; R-CF,1/8W,1.5k      | 2001-000241 ; R-CF,1/8W,1.5k      | 2001-000472 ; R-CF,1/8W,2.7k                                |
| T501         | BH26-00026A ; FQB17A001           | BH26-00026A ; FQB17A001           | BH26-00060A ; FQB17A001M                                    |
| JP120        | -                                 | -                                 | BH39-40305U ; JUMPER WIRE                                   |
| C305         | 2401-000037 ; C-AL,470uF,16V      | 2401-000039 ; C-AL,1000uF,16V     | 2401-000037 ; C-AL,470uF,16V                                |
| D612         | 0402-000546 ; DIODE TVR10G,400V   | 0402-001118 ; DIODE UF1G,400V     | 0402-000546 ; DIODE TVR10G,400V                             |
| R307         | 2001-001048 ; R-CF(S) 1/2W,1.2ohm | 2001-000016 ; R-CF(S) 1/2W,1ohm   | 2001-001048 ; R-CF(S) 1/2W,1.2ohm                           |
| R310         | 2004-000481 ; R-MF,1/4W,2.4K      | 2004-000481 ; R-MF,1/4W,2.4K      | 2004-000481 ; R-MF,1/4W,2.4K                                |
| JP38         | 2004-000458 ; R-MF,1/4W,2.2K      | 2004-000458 ; R-MF,1/4W,2.2K      | 2004-000458 ; R-MF,1/4W,2.2K                                |
| R428         | 2003-000653 ; R-MO,3W,330ohm      | 2003-000608 ; R-MO,3W,270ohm      | 2003-000608 ; R-MO,3W,270ohm                                |
| VIDEO SHIELD | BH71-00006A ; SHIELD VIDEO CAP    | BH71-00006A ; SHIELD VIDEO CAP    | BH75-00047A ; SHIELD VIDEO CAP (EARTH PLATE IMPLEMENTATION) |

| Loc. No.     | LG CDT                            | HITACHI CDT                       | ORION CDT                         |
|--------------|-----------------------------------|-----------------------------------|-----------------------------------|
| R516         | 2002-001056 ; R-COMP,1/4W,180k    | 2002-001056 ; R-COMP,1/4W,180k    | 2002-001056 ; R-COMP,1/4W,180k    |
| R450         | 2001-000837 ; R-CF,1/8W,51k       | 2001-000010 ; R-CF,1/8W,68Kohm    | 2001-000010 ; R-CF,1/8W,68Kohm    |
| R656         | 2001-000411 ; R-CF,1/8W,18KOHM    | 2001-000411 ; R-CF,1/8W,18KOHM    | 2001-000522 ; R-CF,1/8W,22KOHM    |
| R308         | 2001-001107 ; R-CF(S),1/2W,220OHM | 2001-001138 ; R-CF(S),1/2W,390OHM | 2001-001138 ; R-CF(S),1/2W,390OHM |
| R309         | 2004-005002 ; R-MF,1/2W,1.2ohm,2% | 2004-005002 ; R-MF,1/2W,1.2ohm,2% | 2004-005002 ; R-MF,1/2W,1.2ohm,2% |
| R315         | 2004-005002 ; R-MF,1/2W,1.2ohm,2% | 2004-005002 ; R-MF,1/2W,1.2ohm,2% | 2004-005002 ; R-MF,1/2W,1.2ohm,2% |
| CIS          | -                                 | -                                 | -                                 |
| C419         | 2301-001305 ; C-FILM,2.2nF,1.6kV  | 2301-001305 ; C-FILM,2.2nF,1.6kV  | 2301-001305 ; C-FILM,2.2nF,1.6kV  |
| C420         | 2301-001306 ; C-FILM,2.5nF,1.6kV  | 2301-001306 ; C-FILM,2.5nF,1.6kV  | 2301-001306 ; C-FILM,2.5nF,1.6kV  |
| R455         | 2004-000327 ; R-MF,1/4W,150k      | 2004-000327 ; R-MF,1/4W,150k      | 2004-000327 ; R-MF,1/4W,150k      |
| R461         | 2004-000193 ; R-MF,1/4W,100k      | 2004-000193 ; R-MF,1/4W,100k      | 2004-000193 ; R-MF,1/4W,100k      |
| R526         | 2004-000284 ; R-MF,1/4W,12k       | 2004-000284 ; R-MF,1/4W,12k       | 2004-000284 ; R-MF,1/4W,12k       |
| R501         | 2001-000472 ; R-CF,1/8W,2.7k      | 2001-000472 ; R-CF,1/8W,2.7k      | 2001-000472 ; R-CF,1/8W,2.7k      |
| R520         | 2001-000241 ; R-CF,1/8W,1.5k      | 2001-000241 ; R-CF,1/8W,1.5k      | 2001-000241 ; R-CF,1/8W,1.5k      |
| T501         | BH26-00026A ; FQB17A001           | BH26-00026A ; FQB17A001           | BH26-00026A ; FQB17A001           |
| JP120        | -                                 | -                                 | -                                 |
| C305         | 2401-000037 ; C-AL,470uF,16V      | 2401-000037 ; C-AL,470uF,16V      | 2401-000037 ; C-AL,470uF,16V      |
| D612         | 0402-000546 ; DIODE TVR10G,400V   | 0402-000546 ; DIODE TVR10G,400V   | 0402-000546 ; DIODE TVR10G,400V   |
| R307         | 2001-001048 ; R-CF(S) 1/2W,1.2ohm | 2001-001048 ; R-CF(S) 1/2W,1.2ohm | 2001-001048 ; R-CF(S) 1/2W,1.2ohm |
| R310         | 2004-000481 ; R-MF,1/4W,2.4K      | 2004-000481 ; R-MF,1/4W,2.4K      | 2004-000481 ; R-MF,1/4W,2.4K      |
| JP38         | 2004-000458 ; R-MF,1/4W,2.2K      | 2004-000458 ; R-MF,1/4W,2.2K      | 2004-000458 ; R-MF,1/4W,2.2K      |
| R428         | 2003-000653 ; R-MO,3W,330ohm      | 2003-000653 ; R-MO,3W,330ohm      | 2003-000653 ; R-MO,3W,330ohm      |
| VIDEO SHIELD | BH71-00006A ; SHIELD VIDEO CAP    | BH71-00006A ; SHIELD VIDEO CAP    | BH71-00006A ; SHIELD VIDEO CAP    |

# 3 Schematic Diagrams

## 3-1 Main Part Schematic Diagram

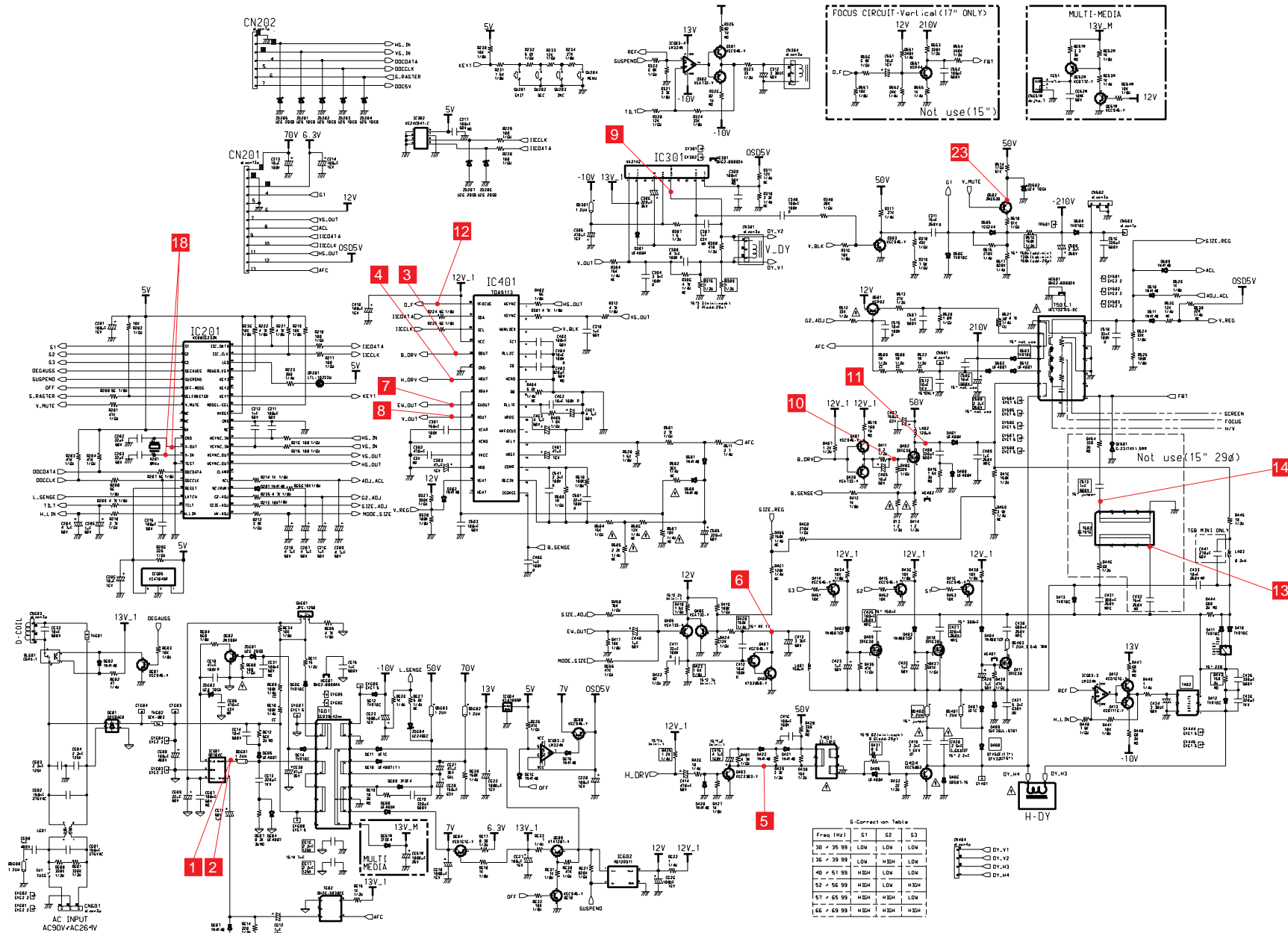

Table 10-1. IC601 (DP104C)

| # in | MODES              |                   |
|------|--------------------|-------------------|
|      | 1024 x 768 / 85 Hz | 640 x 480 / 60 Hz |
| 1    | 285 V              | 286 V             |
| 2    | 0.8 mV             | 0.6 mV            |
| 3    | 18.1 V             | 18.0 V            |
| 4    | 1.51 V             | 2.01 V            |
| 5    | 4.98 V             | 4.98              |

Unit: Vrms

Table 10-2. IC602 (78R12)

| # in | MODES              |                   |
|------|--------------------|-------------------|
|      | 1024 x 768 / 85 Hz | 640 x 480 / 60 Hz |
| 1    | 13.57 V            | 13.50             |
| 2    | 12.05              | 12.05             |
| 3    | -17.0 mV           | -15.5 mV          |
| 4    | 4.99 V             | 4.99 V            |

Unit: Vrms

Table 10-3. IC201 (KS88C623N)

| # in | MODES              |                   | # in | MODES              |                   |
|------|--------------------|-------------------|------|--------------------|-------------------|
|      | 1024 x 768 / 85 Hz | 640 x 480 / 60 Hz |      | 1024 x 768 / 85 Hz | 640 x 480 / 60 Hz |
| 1    | 5.01 V             | 0.47 mV           | 22   | 1.02 V             | 1.02 V            |
| 2    | 5.01 V             | -2.0 mV           | 23   | 2.97 V             | 0.31 V            |
| 3    | 5.01 V             | -3.2 mV           | 24   | 1.14 V             | 1.04 V            |
| 4    | -4.9 mV            | -4.4 mV           | 25   | 7.5 mV             | -8.7 mV           |
| 5    | 5.00 V             | 5.00 V            | 26   | 3.99 V             | 3.99 V            |
| 6    | 4.9 V              | 4.90 V            | 27   | 4.93 V             | 5.0 V             |
| 7    | 31.2 mV            | 30.8 mV           | 28   | 4.73 V             | 4.49 V            |
| 8    | 7.96 mV            | -7.4 mV           | 29   | 11.3 mV            | -11.4 mV          |
| 9    | 9.1 mV             | -85 mV            | 30   | 4.5 mV             | 4.49 V            |
| 10   | 9.9 mV             | -9.4 mV           | 31   | 0.314 V            | 3.98 V            |
| 11   | 5.12 V             | 5.12 V            | 32   | 15.3 mV            | -14.6 mV          |
| 12   | 15.3 mV            | -14.5 mV          | 33   | 15.6 mV            | 5.12 V            |
| 13   | 1.13 V             | 1.13 V            | 34   | 5.12 V             | 5.12 V            |
| 14   | 1.68 V             | 1.70 V            | 35   | 5.11 V             | 5.11 V            |
| 15   | 15.5 mV            | -14 mV            | 36   | 5.11 V             | 5.11 V            |
| 16   | 4.13 mV - 3.9 V    | 41.3 mV - 3.9 V   | 37   | 5.11 V             | 5.11 V            |
| 17   | 3.66 V             | 3.67 V            | 38   | 5.11 V             | 5.11 V            |
| 18   | 4.31 V             | 4.99 V            | 39   | 5.11 V             | 5.11 V            |
| 19   | 4.31 V             | 4.34 V            | 40   | 0.145 V            | 0.146 V           |
| 20   | 2.49 V             | 2.49 V            | 41   | 5.12 V             | 5.12 V            |
| 21   | 2.44               | 0.6 V             | 42   | 5.12 V             | 5.12 V            |

Unit: Vrms

Table 10-5. IC301 (KA2142)

| # in | MODES             |                   |
|------|-------------------|-------------------|
|      | 800 x 600 / 85 Hz | 640 x 480 / 60 Hz |
| 1    | 0.64              | 0.64              |
| 2    | 13.2              | 13.0              |
| 3    | 1.5 mV            | 0.1 mV            |
| 4    | -10.5             | -10.6             |
| 5    | -11.0             | -10.9             |
| 6    | -3.9 mV           | -1.6 mV           |
| 7    | 0 mV              | 0.1 mV            |
| 8    | 0.1 mV            | 0.1 mV            |
| 9    | 12.9 V            | 12.6 V            |
| 10   | 0.64 V            | 0.64 V            |

Unit: Vrms

Table 10-6. IC603 (LM324N)

| # in | MODES              |                   |
|------|--------------------|-------------------|
|      | 1024 x 768 / 85 Hz | 640 x 480 / 60 Hz |
| 1    | 12.01              | 11.8              |
| 2    | 3.06               | 3.60              |
| 3    | 5.12               | 5.12              |
| 4    | 13.5               | 13.3              |
| 5    | 5.12               | 5.11              |
| 6    | 5.12               | 5.12              |
| 7    | 6.51               | 6.43              |
| 8    | 0.66               | 3.96              |
| 9    | 1.63               | 1.63              |
| 10   | 1.63               | 1.63              |
| 11   | 11.19              | -11.1             |
| 12   | 1.63               | 1.63              |
| 13   | 1.63               | 1.63              |
| 14   | 0.70               | -0.68             |

Unit: Vrms

Table 10-7. IC401 (TDA9113)

| # in | MODES              |                   | # in | MODES              |                   |
|------|--------------------|-------------------|------|--------------------|-------------------|
|      | 1024 x 768 / 85 Hz | 640 x 480 / 60 Hz |      | 1024 x 768 / 85 Hz | 640 x 480 / 60 Hz |
| 1    | 4.57 V             | 4.37 V            | 17   | 3.77 V             | 3.78 V            |
| 2    | 2.3 mV             | 4.5 mV            | 18   | 2.72 V             | 2.70 V            |
| 3    | 93.3 mV            | 86.2 mV           | 19   | 1.88 V             | 1.88 V            |
| 4    | 6.25 V             | 6.25 V            | 20   | 5.00 V             | 5.28 V            |
| 5    | 2.80 V             | 3.51 V            | 21   | 14.1 mV            | 16.5 mV           |
| 6    | 3.88 V             | 3.88 V            | 22   | 3.38 V             | 3.38 V            |
| 7    | 14.3 mV            | 17.0 mV           | 23   | 3.17 V             | 3.15 V            |
| 8    | 3.48 V             | 1.55 V            | 24   | 4.09 V             | 2.0 V             |
| 9    | 3.49 V             | 1.55 V            | 25   | 7.23 V             | 7.23 V            |
| 10   | 3.49 V             | 3.53 V            | 26   | 1.05 V             | 1.09 V            |
| 11   | 2.88 V             | 2.67 V            | 27   | 14.0 mV            | 16.8 mV           |
| 12   | 30.3 mV            | 29.9 mV           | 28   | 5.49 V             | 2.34 V            |
| 13   | 7.87 V             | 7.87 V            | 29   | 11.74 V            | 11.74 V           |
| 14   | 3.81 V             | 3.26 V            | 30   | 4.97 V             | 4.97 V            |
| 15   | 5.11 V             | 5.23 V            | 31   | 4.97 V             | 4.97 V            |
| 16   | 0.36 V             | 120.8 mV          | 32   | 3.79 V             | 3.89 V            |

Unit: Vrms

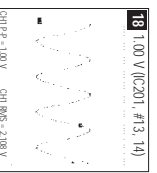
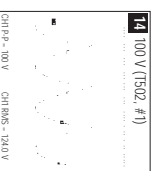
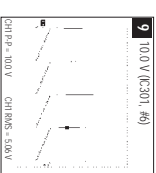
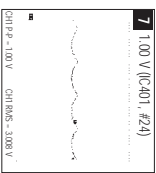
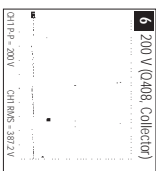
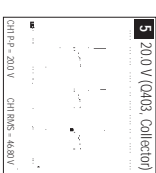
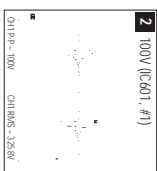
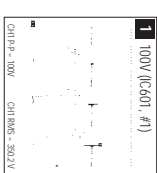



### 3-2 Video Part Schematic Diagram

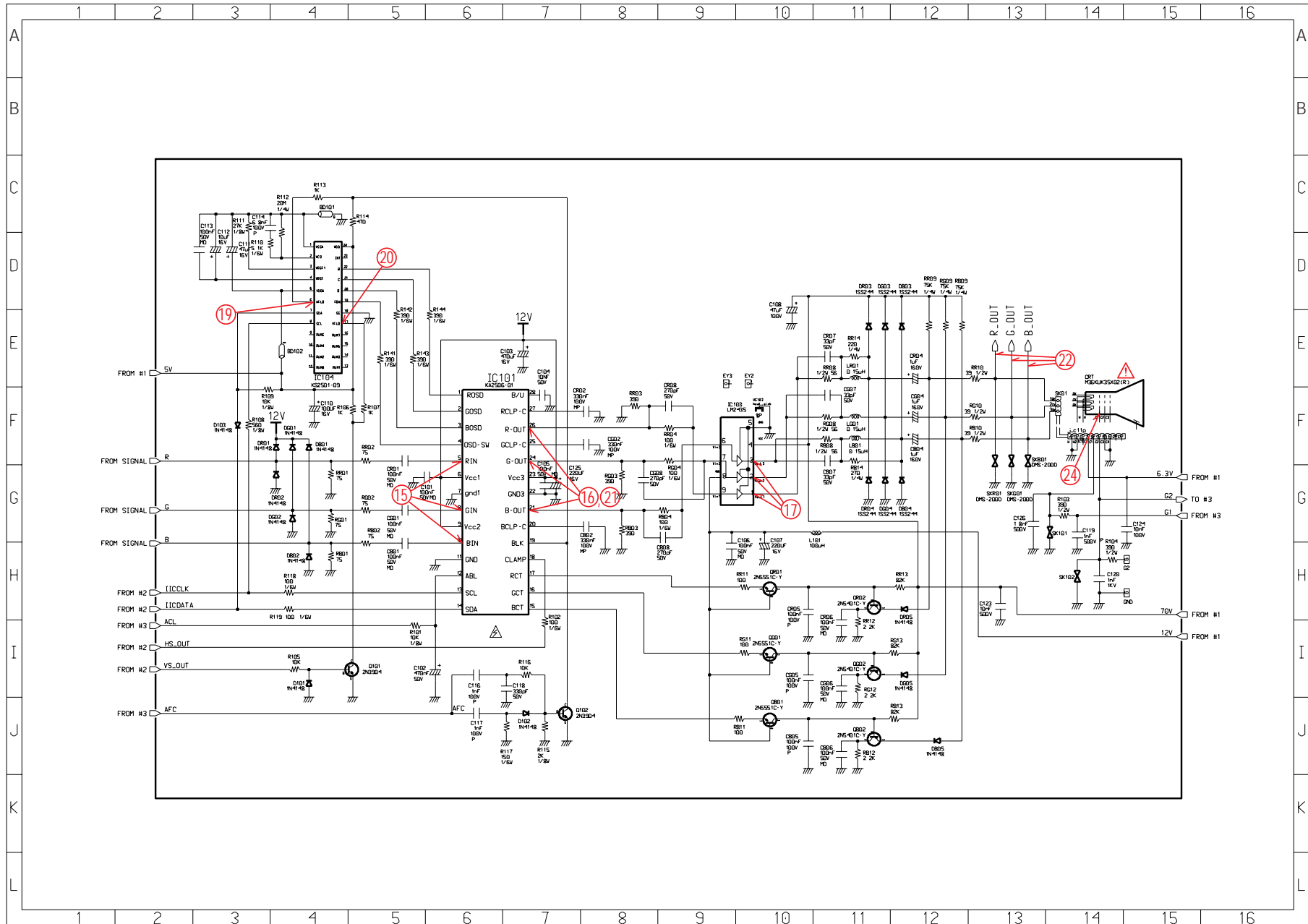

Table 10-8. IC101 (KA2506)

| #  | MODES              |                   | #  | MODES              |                   |
|----|--------------------|-------------------|----|--------------------|-------------------|
|    | 1024 x 768 / 85 Hz | 640 x 480 / 60 Hz |    | 1024 x 768 / 85 Hz | 640 x 480 / 60 Hz |
| 1  | 4.6 mV             | 3.2 mV            | 15 | 11.2 V             | 11.2 V            |
| 2  | 4.5 mV             | 3.2 mV            | 16 | 11.2 V             | 11.2 V            |
| 3  | 4.4 mV             | 3.0 mV            | 17 | 11.2 V             | 11.2 V            |
| 4  | 4.0 mV             | 2.8 mV            | 18 | 4.73 V             | 4.49 V            |
| 5  | 2.47 V             | 2.45 V            | 19 | 4.01 V             | 4.55 V            |
| 6  | 11.8 V             | 11.8 V            | 20 | 4.35 V             | 4.34 V            |
| 7  | 1.06 mV            | 1.0 mV            | 21 | 2.42               | 2.56 V            |
| 8  | 2.42 V             | 2.44 V            | 22 | 1.6 mV             | 1.5 mV            |
| 9  | 11.85 V            | 11.8 V            | 23 | 11.8 V             | 11.8 V            |
| 10 | 2.41 V             | 2.43 V            | 24 | 2.40               | 2.53 V            |
| 11 | 1.44 mV            | 1.39 mV           | 25 | 4.29               | 4.27 V            |
| 12 | 4.22 V             | 4.15 V            | 26 | 2.55               | 2.68 V            |
| 13 | 5.11 V             | 5.11 V            | 27 | 4.31               | 4.29 V            |
| 14 | 5.11 V             | 5.11 V            | 28 | 93.1 mV            | 93.5 mV           |

Unit: Vrms

Table 10-9. IC103 (LM2437)

| # | MODES             |                   |
|---|-------------------|-------------------|
|   | 800 x 600 / 85 Hz | 640 x 480 / 60 Hz |
| 1 | 38.5              | 36.9              |
| 2 | 39.9              | 38.1              |
| 3 | GND               | GND               |
| 4 | 2.4 V             | 2.53              |
| 5 | 2.55              | 2.68              |
| 6 | 11.8              | 11.8              |
| 7 | 2.4 V             | 2.4 V             |
| 8 | 72.8              | 73.2              |
| 9 | 42.5              | 40.2              |

Unit: Vrms

Table 13-10. IC104 (KS2901 ~ 09)

| #  | MODES              |                   |
|----|--------------------|-------------------|
|    | 1024 x 768 / 85 Hz | 640 x 480 / 60 Hz |
| 1  | 1.3 mV             | NC                |
| 2  | 2.24 V             | NC                |
| 3  | 1.26 V             | NC                |
| 4  | 1.27 V             | NC                |
| 5  | 4.93               | 4.91              |
| 6  | 3.99               | 1.9 mV            |
| 7  | 5.11               | 4.9               |
| 8  | 5.11               | 5.3 V             |
| 9  | NC                 | 5.5 V             |
| 10 | NC                 | 5.8 V             |
| 11 | NC                 | NC                |
| 12 | NC                 | 4.93              |

Unit: Vrms

15 1.00 V (IC101, #5, 8, 10)



16 1.00 V (IC101, #21, 24, 26)

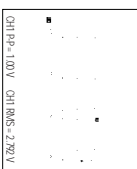

17 20.0 V (IC103, #1, 2, 3)

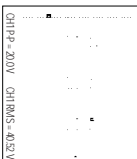

18 1.00 V (IC104, #6)

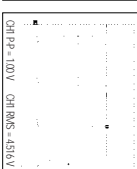

20 1.00 V (IC104, #17)



21 1.00 V (IC101, #21, 24, 26)

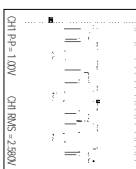

22 10.0 V (R.G.B. Video)

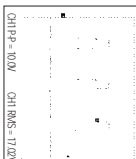

24 20.00 V (CRT, G1)

